

in.k200

compact keypad for in.xe spa systems



Giving full control to wet fingers!





in.k200

Compact series of entry-level keypads that gives complete control to wet fingers!

In.k200 is a compact keypad designed to be used with Aeware's in.xe spa systems.

This new series of entry-level keypads comes in a waterproof plastic enclosure and is available in single pump, dual pump; dual pump/blower or pump/blower configurations.

Easy to install, in.k200 comes with an in.link connector.

Note: The in.xe spa control is also compatible with the following keypads: in.k200, in.k219, in.k235 and in.k400.

Note: The following instructions are generic and provide a quick overview of the main functions. Please refer to your own QRC for specific functions.

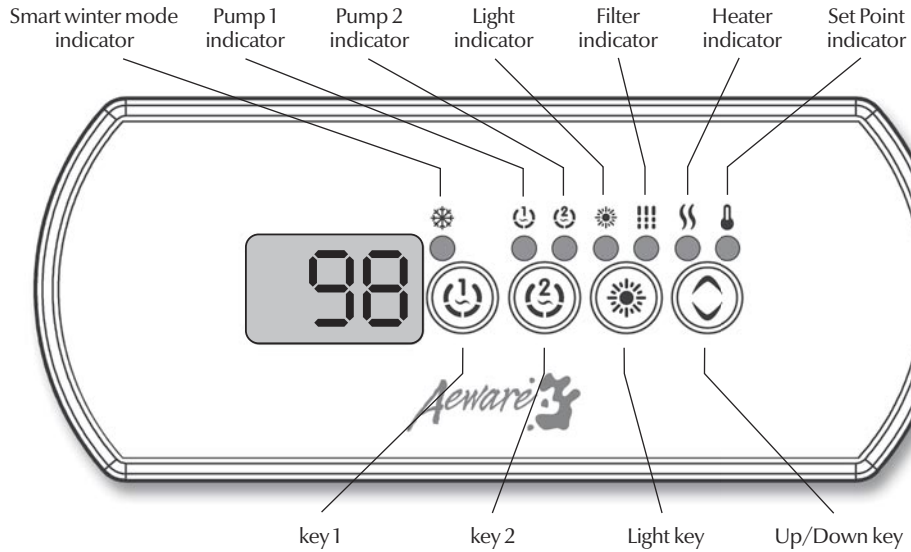



Dimensions:

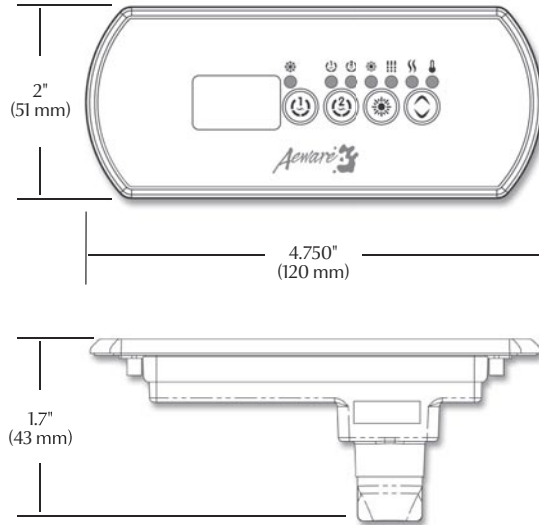

General specifications:

Environmentals:

Storage temperature: 70°C (158°F) to -30°C (-22°F)

Operating temperature: 60°C (140°F) to -20°C (-4°F)

Humidity: 100% condensing

Mechanical Specs:

Weight: 0.41 kg (0.9 lbs)

Dimensions (W x H x D): Front Panel:
120 mm x 51 mm x 43 mm
(4.75" x 2" x 1.7") Soft gasket

Standards: UV resistance (ASMT D4329)
UL, CSA, TUV and CE

Specifications and design are subject to change without notice.



Installing the in.k200

The keypad should be installed directly onto the spa (or very close to it) so that it is easily accessible to the user.

- To install the in.k200, drill two 1" (25 mm) diameter holes at 2 5/8" (67 mm) from center to center as illustrated.
- Cut out the material between the two holes (see illustration).
- Clean the installation surface and peel the adhesive gasket from the back of the keypad.
- Insert keypad and align it correctly, then ensure it's properly glued by gently pressing evenly on the entire surface.

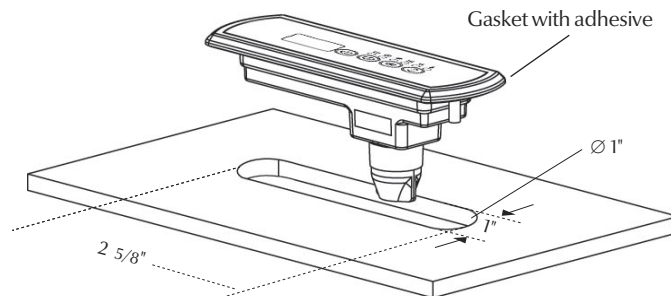
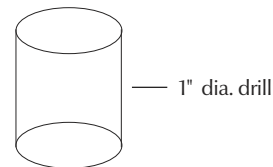
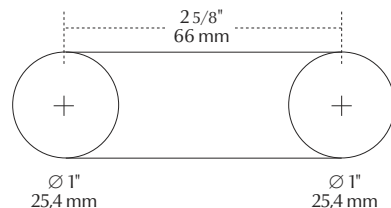

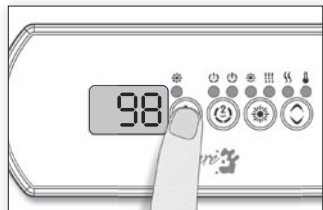

Key 1

Press Key 1 key to turn Pump 1 on at low speed. Press a second time to turn pump to high speed (with a dual-speed pump). A third time turns pump off.

A built-in timer automatically turns pump off after 20 minutes, unless pump has been manually deactivated first.

The “Pump 1” indicator lights up when Pump 1 is on. With dual-speed pump, indicator will flash when Pump 1 is on at low speed.

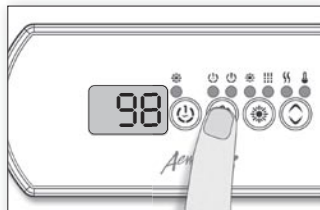

Key 2

2 Pump (or single pump/blower)

Press Key 2 key to turn Pump 2 or Blower on. Press a second time to turn pump or Blower off.

A built-in timer automatically turns pump off after 20 minutes, unless pump or blower has been manually deactivated first.

The “Pump 2” indicator lights up when Pump 2 or blower is on.

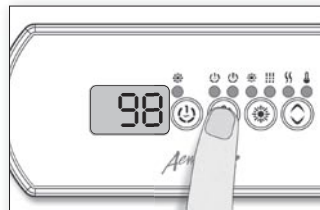

Key 2 (2 Pump/Blower)

Press Key 2 to turn Pump 2 on at high speed. Pressing a second time turns blower on. A third press turns Pump 2 off but leaves blower on. A final press turns blower off. A built-in timer automatically turns Pump 2/blower off after 20 minutes, unless Pump 2/blower has been manually deactivated first.

The “Pump 2” indicator lights up when Pump 2/blower is on.

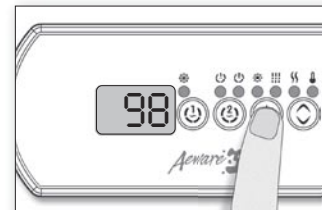

Light key

Press Light key to turn light on. Press Light key a second time to turn light off.

A built-in timer automatically turns light off after 2 hours, unless it has been manually deactivated first.

The “Light” indicator lights up when light is on.



Up/Down key

Use Up or Down key to set desired water temperature. The temperature setting will be displayed for 5 seconds to confirm your new selection.

The "Set Point" icon indicates that the display shows the desired temperature, NOT the current water temperature!

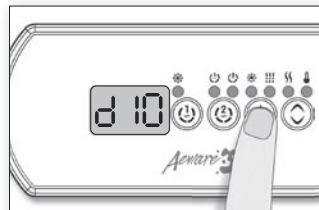

Setting filter cycle duration

Press and hold Light key until the display shows dxx, with "xx" representing the duration in hours. (Default: 2 hours).

Use Up or Down key to change setting.

0 = no filtration
24 = continuous filtration

Note: it's not recommended to set this to "0".

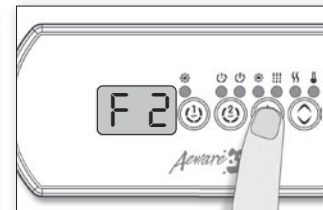

Filter cycle frequency

Press Light key again. The display will show Fx, with "x" representing the number of filter cycles per day (up to 4). (Default: twice a day).

Use Up or Down key to change setting.

When the desired setting is displayed, press Light key to confirm. A filter cycle will start immediately.

The "Filter" indicator lights up when a filter cycle is on.

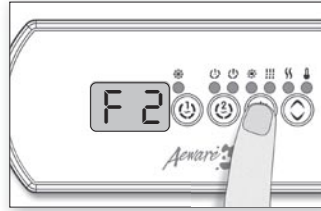

Programming purge cycles

To program the purge cycles, you must select the frequency. During a purge cycle, all pumps and the blower run for one minute.

Purge cycle frequency

Press and hold Light key until the display shows Fx, with "x" representing the number of purge cycles per day (up to 4).

Use Up or Down key to change setting.

When the desired setting is displayed, press Light key to confirm. A purge cycle will start immediately.

The "Filter" indicator lights up when a purge cycle is on.

Water temperature regulation

In a regulation cycle, the system first generates water flow through the heater housing and the plumbing, in order to ensure accurate water temperature readings as well as avoiding heater activation in dry conditions.

After verifying pump activation and taking a water temperature reading if required, the system automatically turns the heater on to reach and maintain water temperature at Set Point.

The "Heater" indicator lights up when the heater is on. It flashes when there is a request for more heat but the heater has not yet started.

Smart Winter Mode

Our Smart Winter Mode protects your system from the cold by turning pumps on several times a day to prevent water from freezing in pipes. The "Smart Winter Mode" indicator lights up when the Smart Winter Mode is on.

Cooldown

After heating the spa water to the desired Set Point, the heater is turned off, but its associated pump (Pump 1 Low-speed or CP) remains on for a certain amount of time to ensure adequate cooling of the heating element, this prolongs its useful life. The heater icon flashes during this time.



Keypads available for the in.xe:

in.k200 (LED display, 4 keys, 7 light indicators)

in.k219 (LED display, 4 keys, 7 function icons)

in.k235 (LED display, 6 keys, 8 function icons)

in.k400 (LCD display, 6 keys, 10 function icons)

Typical settings:

Set Point : 59°F to 104°F / Factory set at 95°F

Filter Cycle Duration: 0 to 24 hrs / Factory set at 2hrs

Filter Cycle Frequency: 1 to 4 times a day / Factory set at 2

Filter Cycle Start: 00:00 to 23:59 / Factory set at 12:00

Pump Runtime: 1 to 255 min. / Factory set at 20 min.

Light Timeout: 1 to 255 min. / Factory set at 120 min.

Max Set Point: 59°F to 104°F / Factory set at 104°F

Gecko Alliance

450 des Canetons, Quebec City (QC) G2E5W6 Canada, 1.800.78.GECKO
9225 Stellar Court, Corona, CA 92883 USA, 951.6672000

www.geckoalliance.com

