

INSTALLATION AND USER MANUAL

MINI SWIM POOL HEAT PUMP

EN/FR

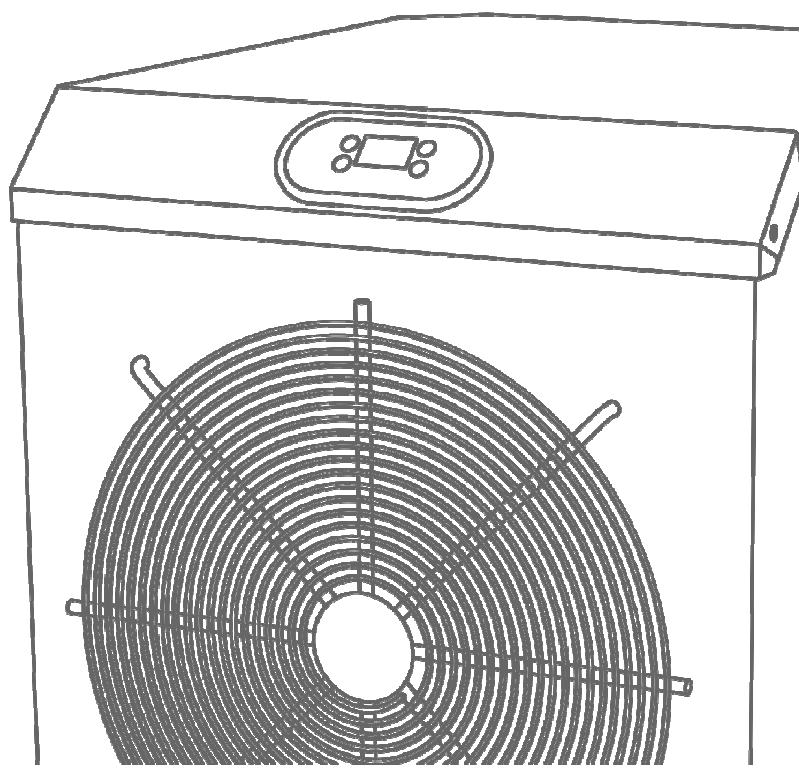

Content

1.	Installation instruction & Operation Points	4
1.1	Installation Locations	4
1.2	Trial.....	5
1.3	Connection	5
1.4	Power Supply	5
1.5	Condensate water	6
2.	Dimension	7
3.	Technical Parameter	8
4.	Operation instruction	9
4.1	Temperature display	9
4.2	Operation	9
5.	Trouble Shooting.....	10
5.1	Trouble shooting for common faults	10
5.2	Failure code.....	10
6.	Daily Maintenance and Product Repair.....	11
6.1	Daily maintenance.....	11
6.2	Product Repair	11

INSTALLATION AND USER MANUAL

Thank you for choosing our product. Its applicable temperature is 10-43 °C.

▲ Note: This manual contains all the necessary information to use and install the heat pump.

1. It must be installed or removed by professionals,
2. Be sure to install a suitable circuit breaker

If abnormal conditions (such as noise, smell, smoke) occur, please immediately turn off the power and contact the seller, do not try to repair it yourself, otherwise it may cause danger.

The main power switch should be placed in a position that children cannot reach, in order to prevent children from playing with the main power switch.

3. Do not put objects such as hands or sticks into the air inlet and outlet of the equipment and do not remove the fan mesh.
4. The main power switch should be placed in a position that children cannot reach, in order to prevent children from playing with the main power switch.
5. Do not put objects such as hands or sticks into the air inlet and outlet of the equipment and do not remove the fan mesh.



Warning:

- a. Please read the following tips before installation, use and maintenance.
- b. Installation, removal and maintenance must be carried out by professional personnel in accordance with the instructions.
- c. Gas leakage test must be done before and after installation.

1. Use

- a. It must be installed or removed by professionals, and it is forbidden to dismantle and refit without permission.
- b. Don't put obstacles before the air inlet and outlet of the heat pump.

2. Installation

- a. This product must be kept away from any source of fire.

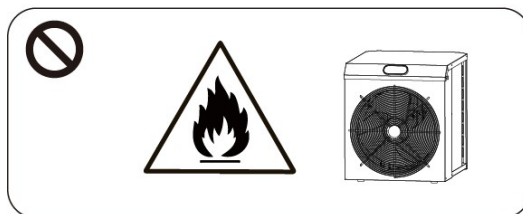

- b. The installation can't be in a closed environment or indoors, and must be kept well ventilated.

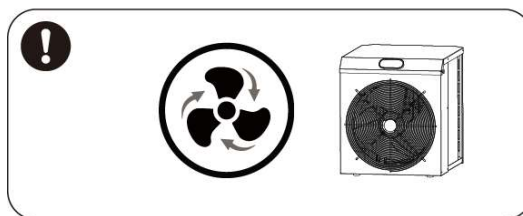

- c. Vacuum completely before welding, field welding is not allowed, welding can only be performed by professional personnel in professional maintenance center.

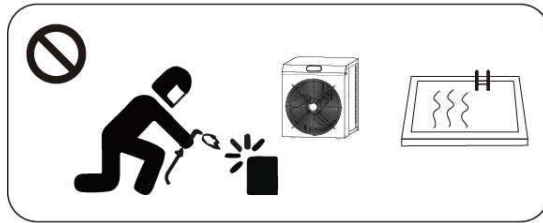

- d. Installation must be stopped if any gas leakage, and the unit must be returned to professional maintenance center.

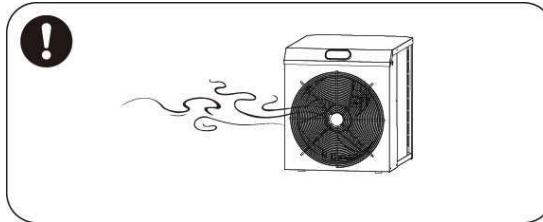

3. Transportation & Storage

- a. Sealing is not allowed during transportation
- b. Transporting goods at a constant speed is needed to avoid sudden acceleration or sudden braking, so as to reduce the collision of goods.
- c. The unit must be far away from any source of fire.
- d. Storage place must be bright, wide, open and good ventilation, ventilation equipment is required.

4. Maintenance Notice

- a. If maintenance or scrap is required, contact an authorized service center nearby

b. Qualification requirement

All operators who dispose gas must be qualified by valid certification which issued by professional agency.

- c. Please strictly comply with the requirement from manufacturer when maintenance or filling gas. Please refer to the technical service manual.

1. Installation instruction & Operation Points

Cautions of Installation:

1. Any chemicals must be guaranteed to be added to the pipes after the heat pump (ie, the chemicals cannot enter the heat pump).
2. When placing or transporting the equipment, it should be placed upwards and kept upright, and must not be dumped or inverted.

1.1 Installation Locations

The product can be installed and used at any predetermined location as long as the following three conditions are met:

- 1) Good ventilation
- 2) Stable power supply
- 3) Pool filter

This heat pump should be installed in a well-ventilated place outside, and the distance from the swimming pool should be greater than or equal to 2 meters. The machine outlet should be at least 1 meter away from the obstacles, and the surrounding obstacles should be at least 0.5 meters. If installed indoors, please consult the installer to keep the room well ventilated.

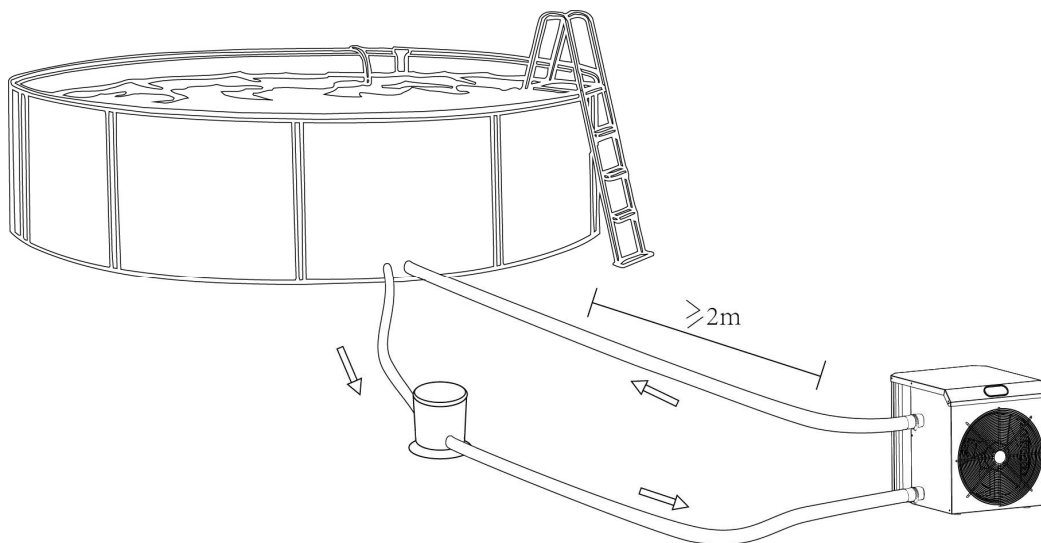

Note: Do not install the unit in a confined or insufficient ventilation location, or in a location where it may block the air intake. These locations can affect the flow air c. It will cause the air to recirculate, resulting in reduced efficiency. It even may stop the system from running.

1.2 Trial

Note: Please ensure the order of “When start, start water pump before heat pump, When finish, turn off heat pump before water pump”, otherwise it will damage the heat pump.

1.3 Connection

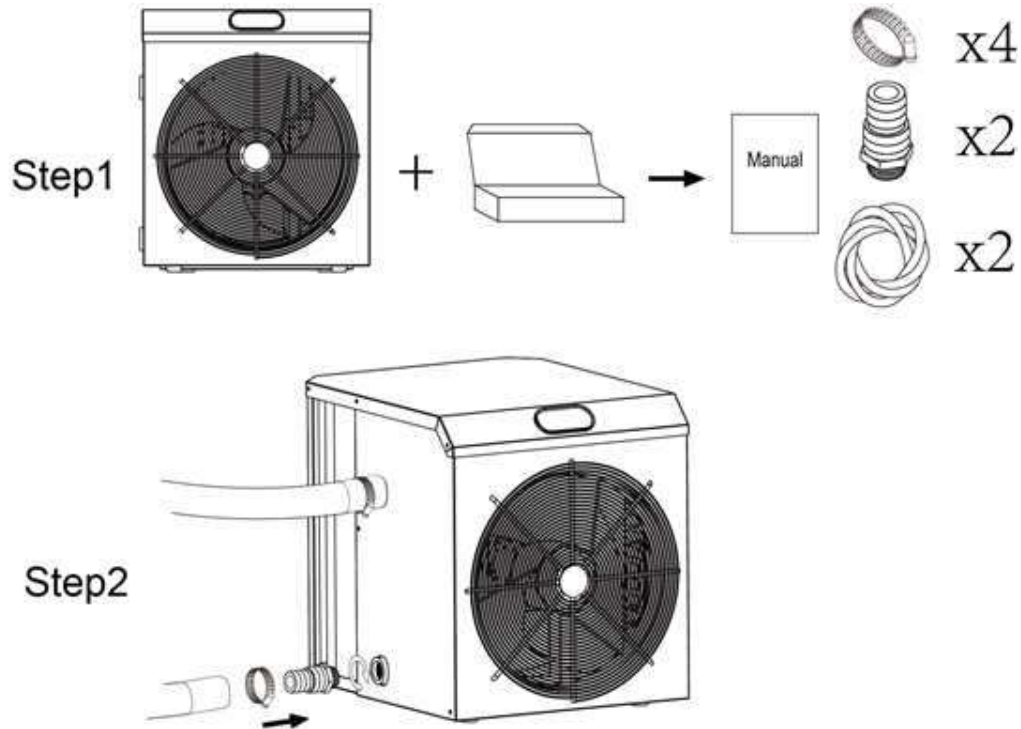

1.4 Power Supply

Before connecting the power supply, make sure that the power supply matches the rated power supply of the product.







Cable Selection of the Protection Device

Model		Onda 03	Onda 05	Onda 07
Breaker	Residual-current circuit breaker	4.5	8.0	9.0
	Rated residual leakage current	30	30	30
Fuse		4.5	8.0	9.0
Power Cord (MM2)		3×1.5	3×1.5	3×1.5

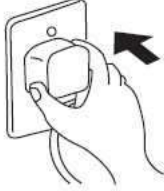
※ Above data is subject to modification without notice.

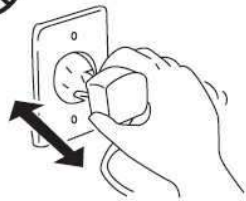
Note: The above data is adapted to power cord ≤ 10m. If power cord is > 10m, wire diameter must be increased. The signal cable can be extended to 50m at most.

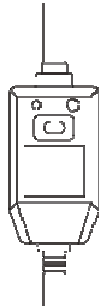
Pay attention:

<p>Please ensure the safety of the power plug.</p> <p>Otherwise, it could cause electric shock or fire.</p>  	<p>Do not disconnect the power supply while the machine is running</p> <p>Otherwise, it could cause an electric shock or fire.</p>  	<p>Do not use damaged or substandard wires.</p> <p>Otherwise, it could cause an electric shock or fire.</p>  	<p>Not Waterproof : RCD plug must be protected against any damage and used in dry environment.</p>  
---	--	--	--

After all connections are complete and checked, perform the following steps:

- 1) The user should start the water pump first to ensure no water leakage in the water pipe system; then set the thermostat at the appropriate temperature after power on.
- 2) In order to protect the machine, it has a delayed start function, after start up, the water pump start, next fan runs, and the compressor will start up automatically after about 3 minutes
- 3) Check if there is any abnormal noise when running
- 4) Check that the set temperature is appropriate

Depending on the initial temperature of the pool water and the air temperature, it may take several days to heat the water to the desired temperature. A good swimming pool cover can greatly reduce the time required.

Time delay - the heat pump has a built-in 3-minute start delay (only started when heated) to protect the circuit and avoid frequent switches causing losses. The machine will restart automatically after the delay period. Even a brief power outage can trigger this delay and prevent the machine from restarting immediately. Power on and off during this delay does not affect the 3-minute duration of the delay.

1.5 Condensate water

The air entering the heat pump is strongly cooled when heat pump heat the pool water, which may cause condensation of the evaporator fins. At higher relative humidity, condensation can reach several liters per hour. This phenomenon is sometimes mistaken for a leak.

2. Dimension

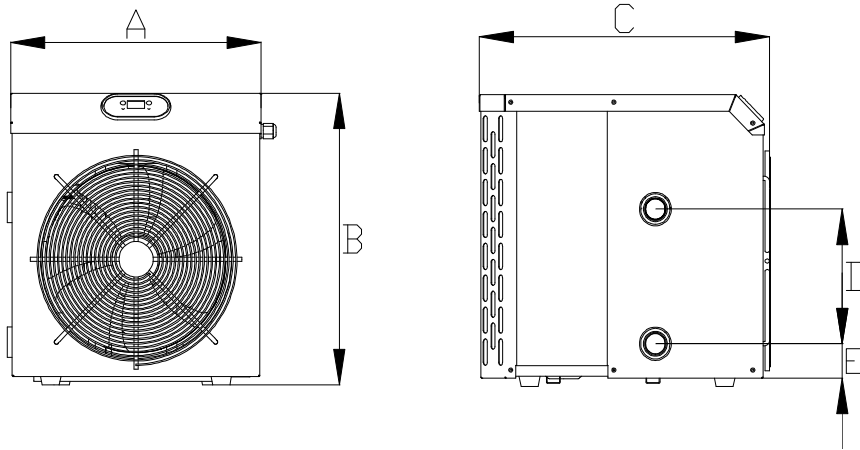

mm) / e	A	B	C	D	E
Onda 03	367	412	425	190	49
Onda 05	445	484	503	300	49
Onda 07	445	484	503	300	49



3. Technical Parameter

Model	Onda 03	Onda 05	Onda 07
Advised pool volume	<20	<28	<35
Operating air temperature	10-43		
Performance Condition: Air 26°C, Water 26°C, Humidity 80%			
Heating capacity	3.5	5.8	7.0
Performance Condition: Air 15°C, Water 26°C, Humidity 70%			
Heating capacity	2.4	3.8	4.8
Power supply	230V/1PH /50Hz		
Advised water flux	1-2	2-3	3-4
Water pipe in-out size	32/38		
Net dimension	412x367x425	484x445x503	484x445x503
Net weight	24	34	38

Above data is subject to modification without notice.

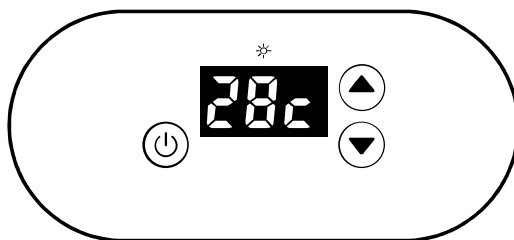
4. Operation instruction







SYMBOL	DESIGNATION	OPERATION
	Power ON/OFF	Press to power on or off the heat pump
	Up/ Down	Press to set desired water temperature



4. 1 Temperature display

28°C is shown on the screen as below for your reference:



4. 2 Operation

- 1) Heat pump turn on/ turn off: when power on, press  to turn on/turn off.
- 2) Water temperature Adjustment: When the heat pump is on, press  or  to modify the setting temperature of the water.
- 3) During heating, “” will be light: the water temperature can be adjusted to (18~40°C)
- 4) Defrosting

Automatic defrosting: When enter to automatic defrost function, the icon  on the top of screen will flash; When finish defrosting, the machine switch automatically to heating function, and the icon  keep lighted.

Note: The heat pump can only be operated while the water circulation/filtration system is running.

5. Trouble Shooting

5.1 Trouble shooting for common faults

FAILURE	REASON	SOLUTION
Heat pump doesn't run	No power	Wait until the power recovers
	Power switch is off	Switch on the power
	Fuse burned	Check and change the fuse
	The breaker is off	Check and turn on the breaker
Fan running but with insufficient heating	evaporator blocked	Remove the obstacles
	Air outlet blocked	Remove the obstacles
	3 minutes start delay	Wait patiently
Display normal, but no heating	Set temp. too low	Set proper heating temp.
	3 minutes start delay	Wait patiently
If above solutions don't work, please contact your installer with detailed information and your model number. Don't try to repair it yourself.		

Note: If the following conditions happen, please stop the machine immediately, and cut off the power supply immediately, then contact your dealer:

- a) Inaccurate switch action;
- b) The fuse is frequently broken or leakage circuit breaker jumped.

5.2 Failure code

Failure code	Failure description
PP1	Water Inlet temperature sensor failure
PP2	Failure for the sensor to connect AIN2 terminal on PC board
PP3	Failure for the sensor to connect AIN3 terminal on PC board
PP4	Gas return temp sensor failure
PP5	Air temp sensor failure
PP7	Heating ambient temperature too low protection
EE1	High pressure protection
EE2	Low pressure protection
EE3	Water flow switch failure

6. Daily Maintenance and Product Repair

6.1 Daily maintenance

- a) Properly set the temperature and humidity for a cozy environment, avoid overheating or excessive cooling.
- b) Don't put obstacles before the air inlet and outlet of the heat pump, or the efficiency of the heat pump will be reduced, even heat pump stopped.
- c) Don't put your hand or the stick into inlet or outlet, do not remove the fan mesh, otherwise the running fan might cause damage to you.
- d) Don't use or store combustible gas or liquid such as thinners, paint and fuel to avoid fire.
- e) Do not rinse the machine directly with water. It is recommended to use household neutral detergent or water to do cleaning. It is strictly forbidden to use volatile oil, gasoline, thinner and other substances.
- f) Please clean the swimming pool and filtration system regularly to avoid damage to the unit due to filter clogging.
- g) Without using in the winter, the power switch must be disconnected; unscrew the inlet pipe to clear the water inside the machine.
- h) Please check regularly the screws for looseness, check whether the wires are worn or not, and whether the connections are secure.

6.2 Product Repair

- a) In case of abnormal conditions (abnormal noise, odor, smoke, electric leakage, etc.), please cut off the power immediately, then contact your local dealer, and inform the product model and fault details. It must be repaired by a professional. Do not disassemble and repair it yourself to avoid any danger!
- b) Before detecting and repairing the machine, you must confirm that the machine has been turned off and disconnected from the power supply; when opening the cover of the electrical box, it must be confirmed that all the indicators in the electrical box have been extinguished before operation.