

YJ3

# TechBook

## in.yj-V3

Small package, zero compromise!



Full-size heater

---

Field convertible 240 V to 120 V

---

Easy spa integration



---

## Table of contents

Warnings .....	2
Introduction .....	3
Features .....	4
Overview	
- in.yj dimensions .....	5
- heat.wav dimensions .....	5
Installation	
- in.yj positioning .....	6
- in.yj installation procedure with standard wall mounting bracket(s) .....	6
- in.yj installation procedure with wall mounting Z-bracket(s) .....	7
- heat.wav installation (not applicable on in.yj-re models) .....	7
- Keypad installation .....	7
Connections	
- Preparation .....	8
- Connecting the main keypad and the light output .....	8
- Connecting the heat.wav (not applicable on in.yj-re models) .....	9
- Connecting high voltage accessories: North American model in.yj .....	10
- Connecting high voltage accessories: European, Australian, New Zealand model in.yj-ce (single phase and dual phase system) .....	11
- Connecting high voltage accessories: North American heat recovery model in.yj-re .....	12
- Connecting the probe (regulation and overheat captor) on the heat recovery model in.yj-re .....	13
- Completing the installation .....	14
Electrical wiring	
- Electrical wiring: all models .....	15
- Electrical wiring: North American model .....	16
- Electrical wiring: CE/AS/NZS models .....	17
Controler power up .....	18
Compatible keypads .....	19
Troubleshooting .....	20
Specifications .....	21

## Warnings



### WARNINGS:

Before installing or connecting the unit, please read the following.

- \* FOR UNITS FOR USE IN OTHER THAN SINGLE-FAMILY DWELLINGS, A CLEARLY LABELED EMERGENCY SWITCH SHALL BE PROVIDED AS PART OF THE INSTALLATION. THE SWITCH SHALL BE READILY ACCESSIBLE TO THE OCCUPANTS AND SHALL BE INSTALLED AT LEAST 5' (1.52 M) AWAY, ADJACENT TO, AND WITHIN SIGHT OF THE UNIT.
- \* ANY DAMAGED CABLE MUST BE IMMEDIATELY REPLACED BY QUALIFIED PERSONNEL.
- \* TURN POWER OFF BEFORE SERVICING OR MODIFYING ANY CABLE CONNECTIONS IN THIS UNIT.
- \* TO PREVENT ELECTRIC SHOCK HAZARD AND/OR WATER DAMAGE TO THIS CONTROL, ALL UNUSED BUSHING CONDUITS MUST BE PLUGGED WITH THE ATTACHED NIPPLE.
- \* THIS CONTROLLER MUST NOT BE INSTALLED IN PROXIMITY OF HIGHLY FLAMMABLE MATERIALS.
- \* LOW SUPPLY VOLTAGE OR IMPROPER WIRING MAY CAUSE DAMAGE TO THIS CONTROL SYSTEM. READ AND FOLLOW ALL WIRING INSTRUCTIONS WHEN CONNECTING TO POWER SUPPLY.
- \* THIS PACK CONTAINS NO USER SERVICEABLE PARTS. CONTACT AN AUTHORIZED SERVICE CENTER FOR SERVICE.
- \* ALL CONNECTIONS MUST BE MADE BY A QUALIFIED ELECTRICIAN IN ACCORDANCE WITH THE NATIONAL ELECTRICAL CODE AND ANY STATE, PROVINCIAL OR LOCAL ELECTRICAL CODE IN EFFECT AT THE TIME OF THE INSTALLATION.
- \* PRODUCT MUST BE DISPOSED OF SEPARATELY IN ACCORDANCE WITH LOCAL WASTE DISPOSAL LEGISLATION.
- \* THIS APPLIANCE IS NOT INTENDED FOR USE BY PERSONS (INCLUDING CHILDREN) WITH REDUCED PHYSICAL, SENSORY OR MENTAL CAPABILITIES, OR LACK OF EXPERIENCE AND KNOWLEDGE, UNLESS THEY HAVE BEEN GIVEN SUPERVISION OR INSTRUCTION CONCERNING USE OF THE APPLIANCE BY A PERSON RESPONSIBLE FOR THEIR SAFETY.
- \* CHILDREN SHOULD BE SUPERVISED TO ENSURE THAT THEY DO NOT PLAY WITH THE APPLIANCE.
- \* MEANS FOR DISCONNECTION MUST BE INCORPORATED IN THE FIXED WIRING IN ACCORDANCE WITH THE WIRING RULES.
- \* CAUTION: IN ORDER TO AVOID A HAZARD DUE TO INADVERTENT RESETTING OF THE THERMAL CUT-OUT, THIS APPLIANCE MUST NOT BE SUPPLIED THROUGH AN EXTERNAL SWITCHING DEVICE, SUCH AS A TIMER, OR CONNECTED TO A CIRCUIT THAT IS REGULARLY SWITCHED ON AND OFF BY THE UTILITY.
- \* PARTS CONTAINING LIVE PARTS, EXCEPT PARTS SUPPLIED WITH SAFETY EXTRA-LOW VOLTAGE NOT EXCEEDING 12 V, MUST BE INACCESSIBLE TO A PERSON IN THE BATH OR SPA.
- \* PARTS INCORPORATING ELECTRICAL COMPONENTS, EXCEPT REMOTE CONTROL DEVICES, MUST BE LOCATED OR FIXED SO THAT THEY CANNOT FALL INTO THE BATH OR SPA.
- \* PARTS ARE TO BE INSTALLED IN THE CORRECT ZONE AND EQUIPOTENTIAL BONDING CARRIED-OUT IN ACCORDANCE WITH THE WIRING RULES.
- \* CLEARANCE AND MINIMUM DISTANCE BETWEEN THE VARIOUS PARTS OF THE APPLIANCE AND THE SURROUNDING STRUCTURE ARE NOT SPECIFIED AS LONG AS THEY ARE SUFFICIENT SO THAT THE AMBIENT TEMPERATURE AROUND THE CONTROLLER DOES NOT EXCEED 60°C

Aeware®, Gecko®, and their respective logos are Registered Trademarks of Gecko Alliance Group. in.yj™, in.keys™, in.touch™, in.k200™, in.k400™, in.k450™, in.k600™, K-19™, K-35™, K-8™, in.k1000™, in.k800™, in.k500™, in.k300™, in.flo™, in.put™, in.seal™, in.link™, in.t.cip™, in.stik™, heat.wav™, Y Series™, and their respective logos are Trademarks of Gecko Alliance Group.

All other product or company names that may be mentioned in this publication are tradenames, trademarks or registered trademarks of their respective owners.

---

## Introduction



# in.yj-V3

small package, zero compromise

### **A lot more in the same small box**

It's well known that the best-selling in.yj-V3 is the nicest control system for small footprint spas. But the temptation to muscle it up and make it the best there is proved irresistible. With its boosted CPU, more memory and higher capacity relays, in.yj-V3 now has the power it needs for new features... like an updated FLO circuit, LED lights for troubleshooting clues and dual phase CE configuration so it can be used anywhere in the world.

### **Relaxation in full colors with in.mix integration**

With a light output capacity increased to 1A and the integration of the in.mix 300 color system on the main board, new in.lu.me cables and LED lights can be connected directly to the in.yj-V3 box with full color control directly from the keypad.

### **Now connects to the Internet of Things**

We've added a pathway to connected accessories with faster communication, not only to open up the in.yj-V3 to the network of connected objects but to be updatable wirelessly, a definite plus for our OEM customers. All this in the same small control box!

## Features

---

The Y Series systems boast a long list of technical features. Each of them contributes to bringing the most advanced solutions available to Y Series equipped spa owners:



**in.seal**  
watertight protection

In.seal provides an extra level of protection against water infiltration. Connectors and power box are designed to be watertight so that no water can be in direct contact with electrical components (IPX5).



**in.flo**  
dry-fire protection

in.flo is an all-electronic dry-fire protection that is built in to the remote heat.wav heater. The in.flo eliminates the burden of adjustments, calibrations and failures associated to usual water flow sensors.



**in.stik**  
automated software upload

The in.stik is a pen drive with an in.link connector very similar to a USB memory stick. It connects to the spa pack and contains data to program or configure its system. The system executes the data upload automatically.



**in.t.cip**  
water temperature algorithm

in.t.cip is an intelligent water temperature refresh algorithm that calculates optimal time to start pumps and get water temperature readings. In.t.cip continuously readjusts the heater start time (according to exterior temperature).



**in.touch**  
you're always in touch with your relaxation

All Y Series packs support the in.touch WiFi interface, allowing you to use your favorite iOS device to communicate with your spa.



**in.link**  
ingenious plugs and connectors

The Y Series is only compatible with the low-voltage family of in.link connectors, such as those used by keypads and similar low-voltage accessories.



**in.put**  
input terminal block

In.put was designed to ease wire insertion (up to # 6 AWG) and connections. Tighter input connection reduces heat generated for increased component lifetime.

# Overview

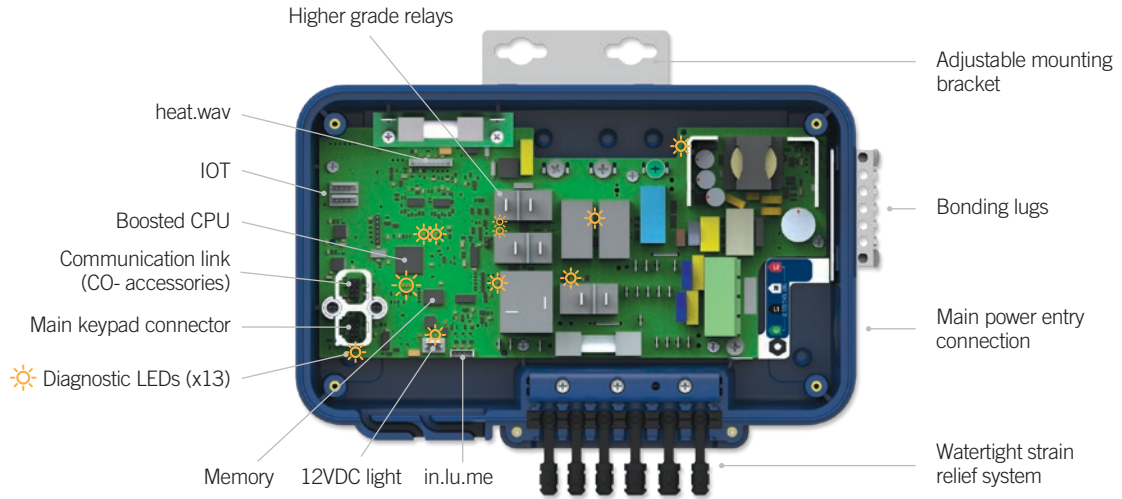

## in.yj dimensions



## heat.wav dimensions

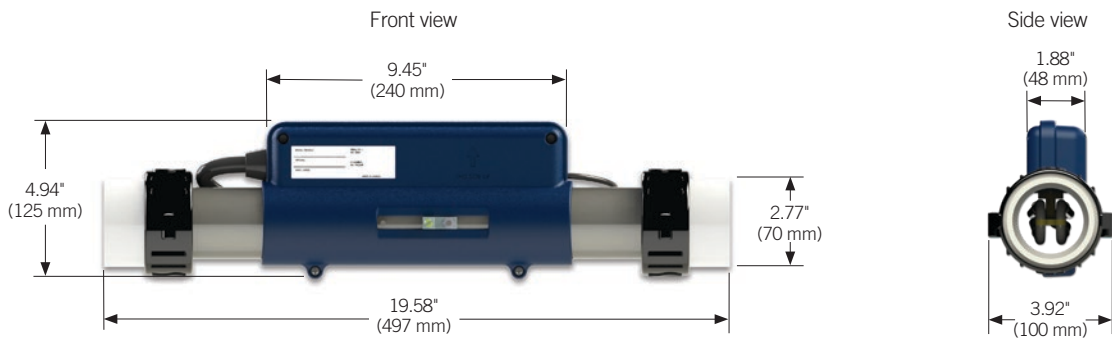

Note: Shown with optional wall mouting brackets (see Installation).

## Installation

### in.yj positioning

To prevent water from getting inside 2 positions are allowed.

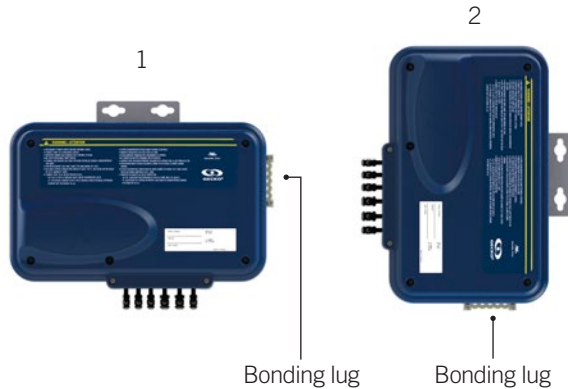

#### **Warning!**

Beware of the application of some products commonly used against corrosion (such as WD-40 family products) as they could damage the pack, due to a negative chemical reaction between some industrial oils and its plastic enclosure. Any other materials which may come in contact with the enclosure must be carefully evaluated under end use conditions for compatibility.

Two types of brackets can be used to secure the pack:

in.yj installation procedure with standard wall mounting bracket(s)

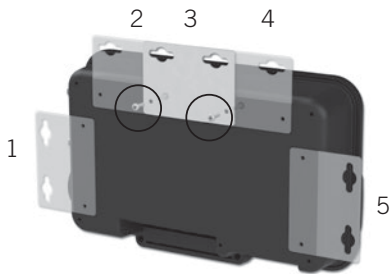

Flat aluminum brackets are designed for back wall mounting. There are 5 possible positions you can use. Multiple brackets can be used if extra support is needed.

Fasten the mounting bracket(s) to the back of the pack with the supplied screws.

*Part number:  
Wall mount bracket kit 100 pcs - 9920-101474  
(with 200 screws to attach to pack)*

Using the brackets, fasten pack to 2" x 4" or 2" x 6" timber wall studs under the spa. We recommend using #10 self threading screws with pan or truss heads and washers 1/2" OD x 1/16" (12 mm OD x 1.5 mm).

*Note: The spa pack must be installed at least 4" (100 mm) above potential flood level. If floor is on ground level, pack should be raised at least 4" (100 mm).*

## Installation

### in.yj installation procedure with wall mounting Z-bracket(s)

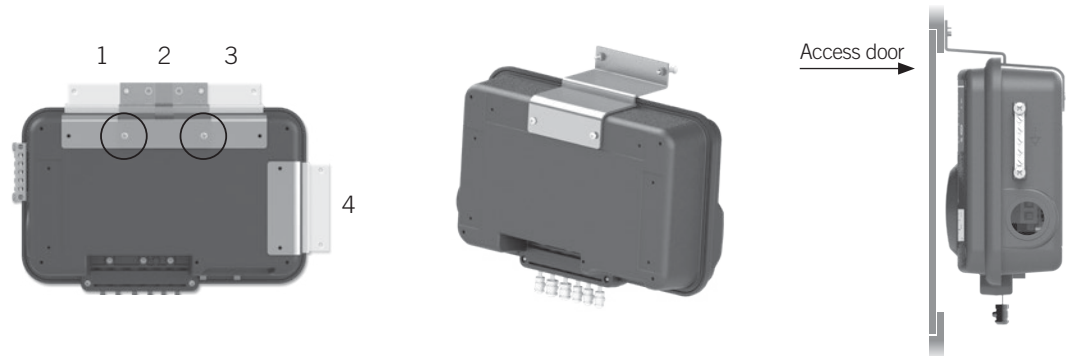

The aluminum Z-bracket is designed for flush-mounting the pack directly on the edge of the access door frame of your spa. It can be mounted to the pack in one of 4 positions for greater flexibility.

Fasten the mounting bracket(s) to the back of the pack with the supplied screws.

*Part number:  
Z-bracket in.yj kit 100 pcs - 9920-101478  
(with 200 screws to attach to pack)*

Depending on your specific needs, you can fasten with two #10-24 screws of your choice.

*Note: The spa pack must be installed at least 4" (100 mm) above potential flood level. If floor is on ground level, pack should be raised at least 4" (100 mm).*

### heat.wav installation (not applicable on in.yj-re models)



The heat.wav heating element must be installed in the return circuit of the main pump (pressure side).

### Keypad installation

For detailed installation instructions and a drilling template, refer to the [compatible keypad](#) section and select your keypad to be redirected to the corresponding techbook.



## Connections

### Preparation

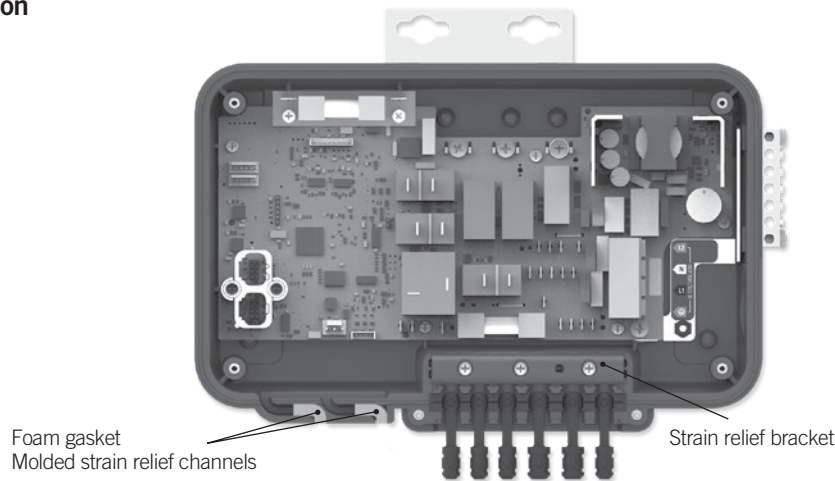

Remove the cover screws from the front of the pack with a Phillips screw driver.

Remove and put aside the strain relief bracket and the foam gasket located in the molded strain relief channels.

### Connecting the main keypad and the light output

*Note: always shut power down before connecting an accessory to the pack.*

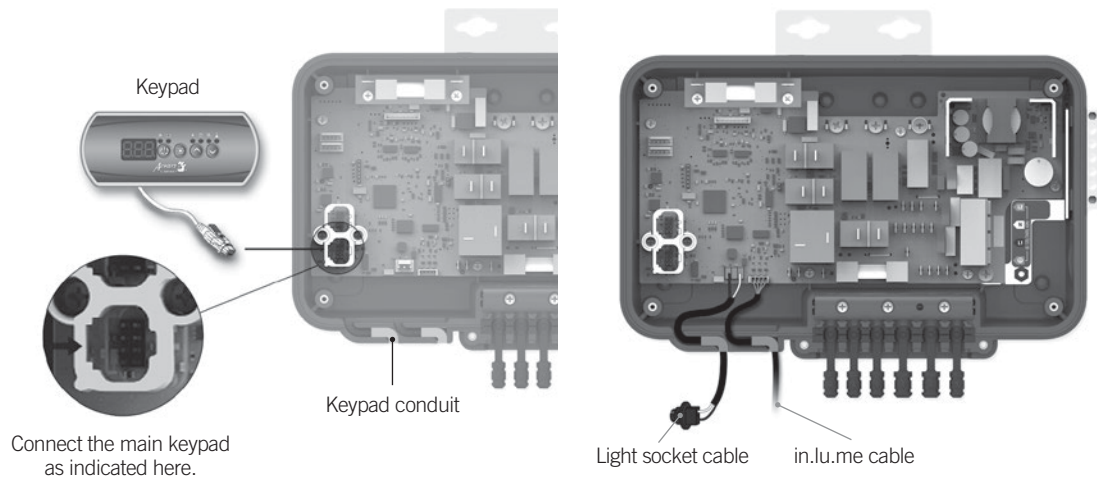

To connect the keypad, insert the in.link connector into the appropriate keypad connector (as illustrated).

To connect the light socket cable, insert the MTA connector into the 12 V DC light output connector P33. To connect the in.lu.me cable, insert the JST 4 pin connector into the LEDs RGB output connector P38 (as illustrated).

*Part number:  
Light socket cable - 9920-400489  
in.lu.me cable - 0699-500013, 0699-500018, 0699-500019  
& 0699-500022.*

Route the low voltage cables through the molded strain relief channels on the bottom of the spa pack.

## Connexions

### Connecting the heat.wav (not applicable on in.yj-re models)

The in.yj should be paired with a high performance heat.wav heater.

Part numbers:

1,3 kW heat.wav - 0613-421004

2 kW heat.wav - 0613-421002

3 kW heat.wav - 0613-421003

4 kW heat.wav - 0613-421001

heat.wav specification summary:

- in.flo integrated dry-fire protection
- Supports 120 V or 240 V
- Protected by external breaker (not fused)\*
- Incoloy® heater element

*\*Note: CE/AUS/NZS models are 230-240 V only, and are fuse protected.*

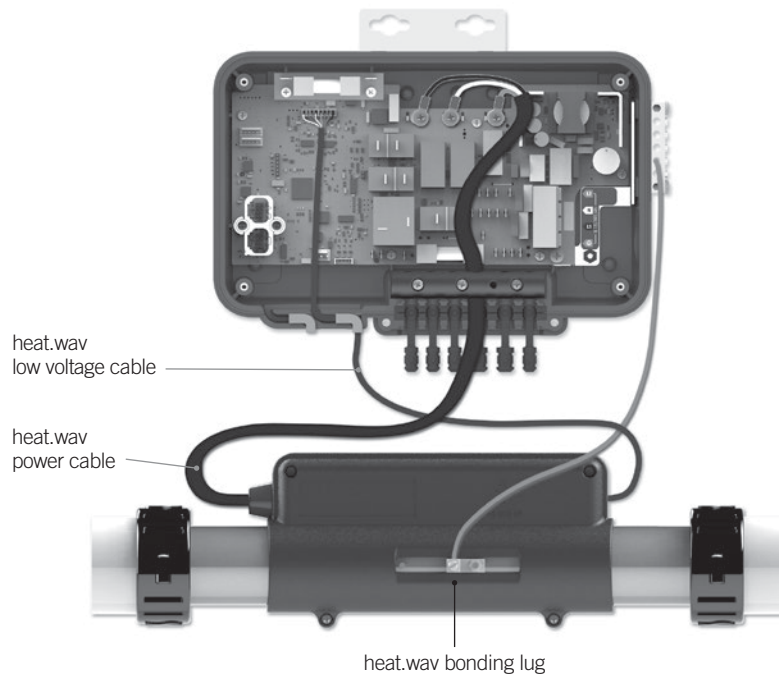

*Note: always shut power down before connecting an accessory to the pack.*

Connect a solid copper conductor (not smaller than 8 AWG) between the bonding lugs on the side of the spa pack and the bonding lug at the front of the heat.wav. The bonding conductor should be routed close to the contour of the equipment to reduce the risk of damage during servicing.

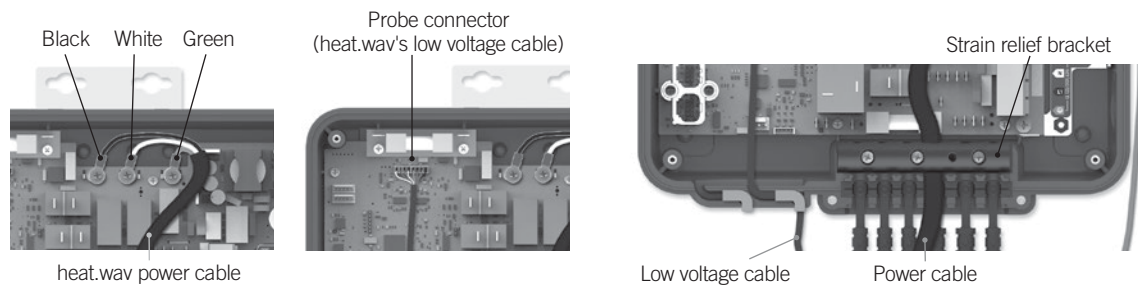

Connect the colored wires  
black = P3  
white = P4  
green = P5

To connect the heat.wav low voltage cable, insert the JST into the probe connector (P1).

Route the low voltage cable through one of the molded power strain relief channels on the bottom of the spa pack.

Remove the small rubber stopper. Route the power cable through one of the openings for 12-3 cable size (as illustrated on page 14).

*Note: Do not over tighten screws (torque to 18 in. lb max (2.0N.m.) and use of a tool up to 500 rpm max)*

**Connecting high voltage accessories: North American model in.yj**

Wires to connect high voltage accessories must have 0.25" quick-connect terminals.

These tabs require high-voltage accessories to have straight, non-insulated, female quick-connect terminals for all connections, including ground. Depending on where the connections are made on the in.yj pack PCB, 120 V and 240 V accessories are supported. Refer to the following tables for correct connections. Note that all female terminals must be correctly and completely seated on the PCB tab for proper current ratings.

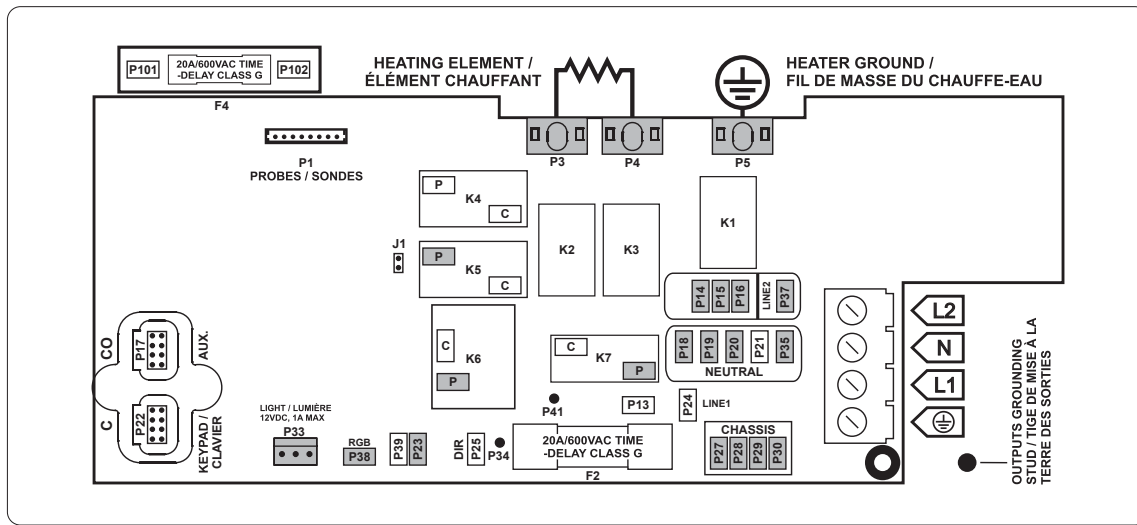

Make sure all accessories are linked to the bonding lug connector located on the side of the spa pack.

Direct output		Pump 1		Pump 2 (in.yj-3 only)		Ozone (Working with pump 1 low speed)	
Voltage	120 V 240 V	Voltage	120 V 240 V	Voltage	120 V 240 V	Voltage	120 V 240 V
Green / ground	P27 P27	Green / ground	P28 P28	Green / ground	P29 P29	Green / ground	P30 P30
Black / line	P25 P25	Black / low speed	K6-P K6-P	Black / low speed	K5-P K5-P	Black / line	P23 P23
White / common	P18 P14	Red / high-speed	K7-P K7-P	White / common	P20 P16	White / common	P35 P37
		White / common	P19 P15				

Light (12 V DC, 1A)*		Heat.wav-yj		RGB LEDs in.lu.me (1A)*	
Switch	P33	Green / ground	P5	Switch	P38
		Black / line	P3		
		White / common	P4		

\* Combination of both outputs is limited to 1A.

This table shows typical connections. OEMs may have a different connection scheme.

## Connections

### Connecting high voltage accessories: European, Australian, New Zealand model in.yj-ce (single phase and dual phase system)

These tabs require high-voltage accessories to have straight, non-insulated, female quick-connect terminals for all connections, including ground. Refer to the following tables for correct connections. Note that all female terminals must be correctly and completely seated on the PCB tab for proper current ratings.

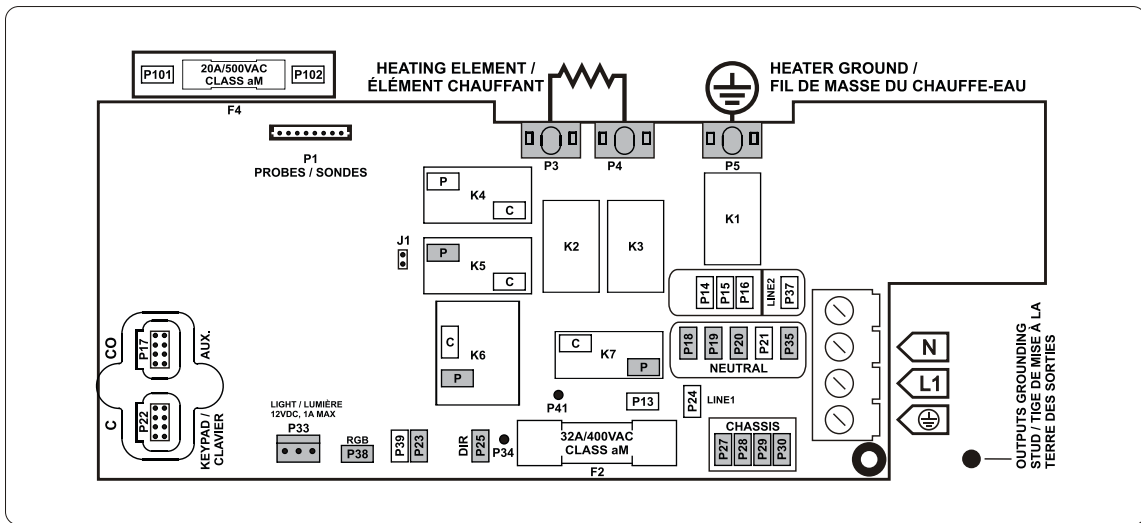

Make sure all accessories are linked to the bonding lug connector located on the side of the spa pack.

Direct output	230 V	Pump 1	230 V	Pump 2 (in.yj-3 only)	230 V	Ozone (Working with pump 1 low speed)	230 V
Ground	P27	Ground	P28	Ground	P29	Ground	P30
Line	P25	Low speed	K6-P	Low speed	K5-P	Line	P23
Common	P18*	High speed	K7-P	Common	P20	Common	P35
		Common	P19				

Light (12 V DC, 1A)*	Heat.wav-yj	RGB LEDs in.lu.me (1A)*
Switch	Green / ground	Switch
		P38
	Black / line	
	White / common	

\* For dual phase system use P21 instead of P18

\* Combination of both outputs is limited to 1A.

This table shows typical connections. OEMs may have a different connection scheme.

## Connections

### Connecting high voltage accessories: North American heat recovery model in.yj-re

These tabs require high-voltage accessories to have straight, non-insulated, female quick-connect terminals for all connections, including ground. Refer to the following tables for correct connections. Note that all female terminals must be correctly and completely seated on the PCB tab for proper current ratings.

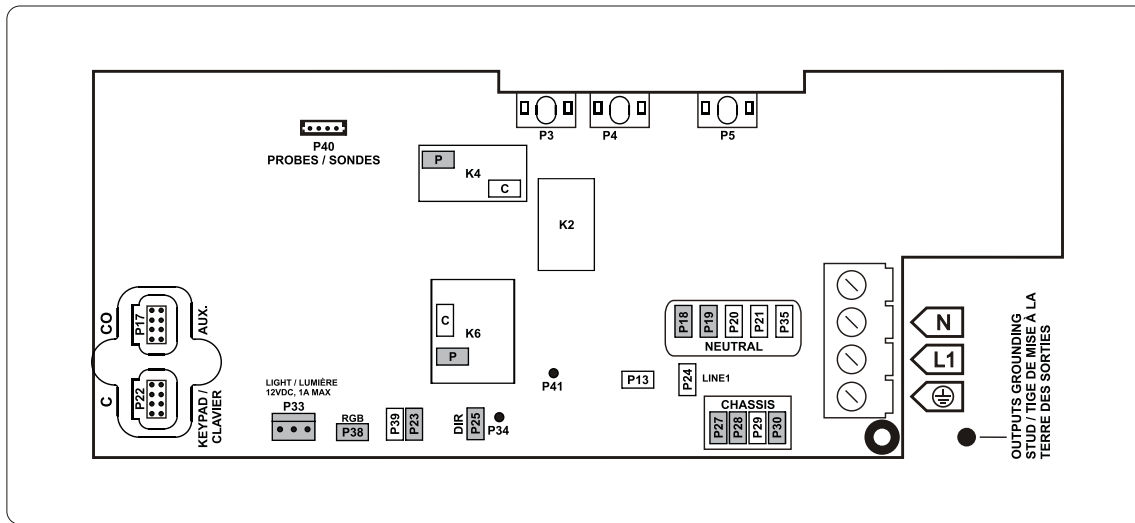

Make sure all accessories are linked to the bonding lug connector located on the side of the spa pack.

Direct output Voltage	120 V	Pump 1 Voltage	120 V	Ozonateur Voltage	120 V	Light (12 V DC, 1A)*	
Green / ground	P27	Green / ground	P28	Green / ground	P30	Switch	P38
Black / line	P25	Black / low speed	K6-P	Black / line	P23		
White / common	P18	Red / high speed	K4-P	White / common	P35		
		White / common	P19				

RGB LEDs in.lu.me (1A)*	
Switch	P38

\* Combination of both outputs is limited to 1A.

This table shows typical connections. OEMs may have a different connection scheme.

---

## Connections

### Connecting the probe (regulation and overheat captor) on the heat recovery model in.yj-re

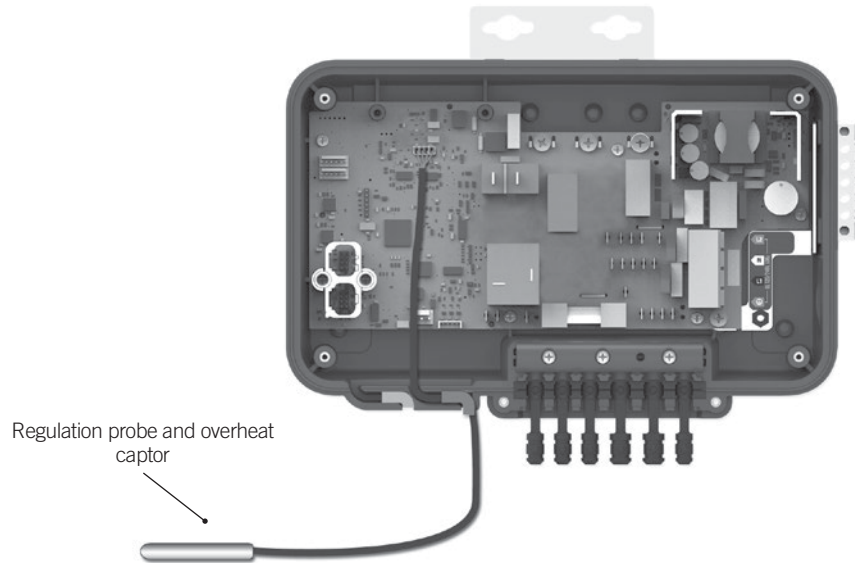

The probe assembly must be installed in the spa water in an area where water is not stagnant in order to optimize the temperature regulation.

To connect the probe assembly cable, insert the JST into the probe connector (P40).

Route the probe assembly cable through one of the molded strain relief channels on the bottom of the spa pack.

*Part number:*  
*Regulation probe and overheat captor - 9920-401397*

Completing the installation

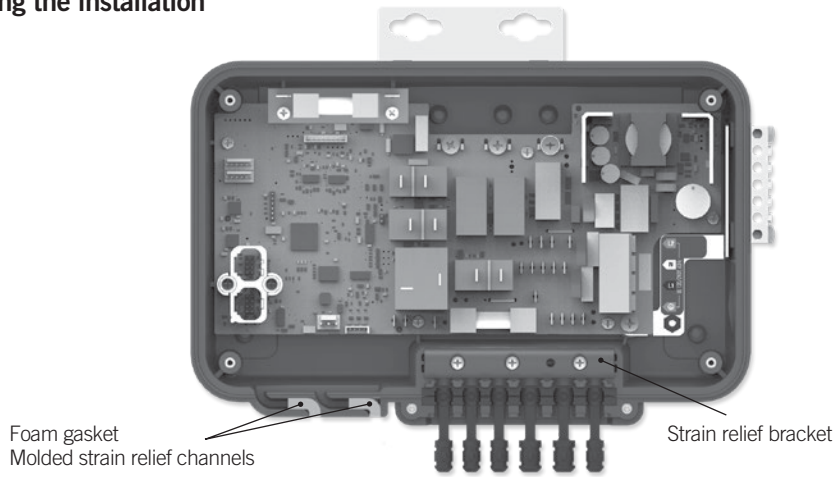

Once all low voltage cables are routed through the molded strain relief on the bottom of the spa pack, fill the remaining space with the foam gasket supplied.

Once all high voltage accessories cables are routed through one of the openings provided for this purpose at the bottom of the spa pack, you can reinstall the strain relief bracket.

Replace the cover. Do not over tighten cover screws (torque to 8 in. lb max (0.9N.m.)

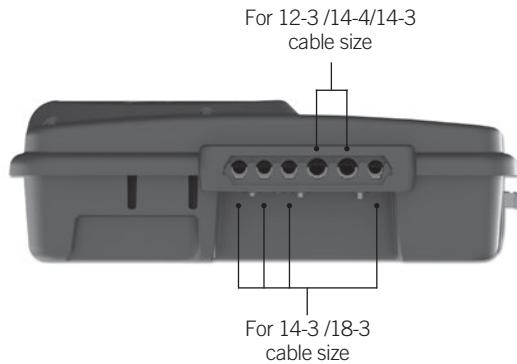

Output cable opening size

## Electrical wiring

### Electrical wiring: all models

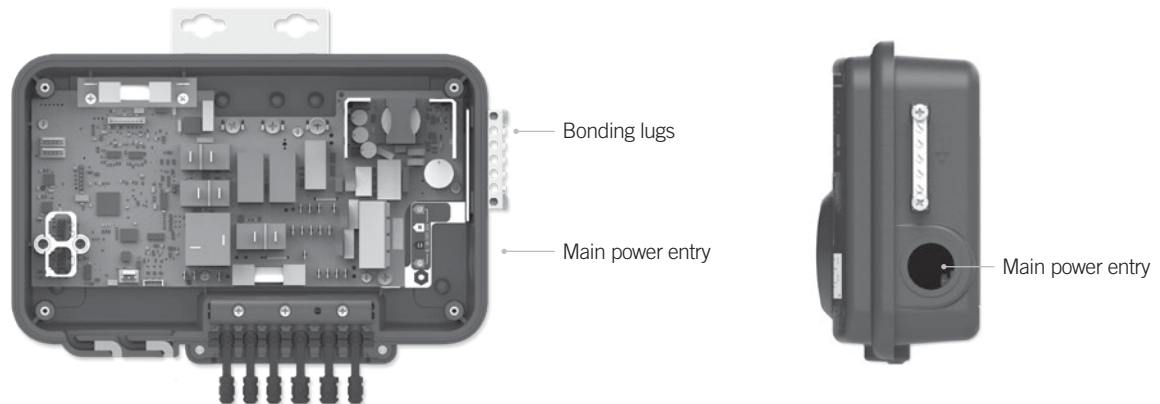

#### **Warning!**

Disconnect power before starting electrical work. Wiring must be completed by a qualified electrician and must be done in accordance with the local electrical code.

Do not use a wire gauge bigger than 8 AWG.

To complete the electrical connections of the in.yj control system you will need a Phillips screwdriver and a flat-head screwdriver.

Remove the screws from the system control lid and remove it.

Remove 5 1/2" (142 mm) of cable insulation.

Strip away 1/2" (15 mm) of insulation from each wire.

Pull the cable through the cutout of the box and secure it with a 3/4" NPT strain relief\* (hole diameter 1.09" {27.6 mm}). Ensure that the NPT strain relief clamps around the outer sheath of the cable.

*\*For CE/AUS/NZ use an IEC certified plastic bushing that will maintain the IPX5 rating.*

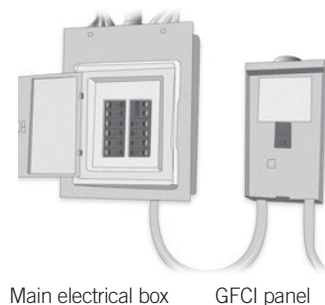

Main electrical box      GFCI panel

#### **Warning!**

For units for use in other than single-family dwellings, a clearly labeled emergency switch shall be provided as part of the installation. The switch shall be readily accessible to the occupants and shall be installed at least 5' (1.52 m) away, adjacent to, and within sight of the unit.

-----  
This product must always be connected to a circuit protected by a ground fault interrupter.

-----  
Proper wiring of the electrical service box, GFCI and in.yj terminal block is essential!

-----  
Check your electrical code for local regulations. Only copper wire should be used, never aluminum.

#### **Disposal of the product**

 The appliance (or the product) must be disposed of separately in accordance with the local waste disposal legislation in force.



## Electrical wiring

### Electrical wiring: North American model

Refer to wiring diagram in the enclosure box lid for more information.

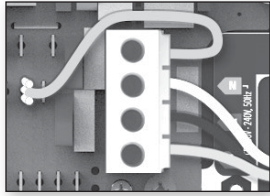

**120 V (3 wires)**

DO NOT REMOVE THE BROWN WIRE. Insert each wire into the appropriate socket of the main entry terminal block according to the color code indicated on the sticker. Use a flat screwdriver to tighten the screws on the terminal.

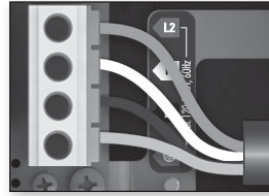

**240 V (4 wires)**

Remove the brown wire and insert each wire into the appropriate socket of the main entry terminal block according to the color code indicated on the sticker. Use a flat screwdriver to tighten the screws on the terminal.

After making sure wires are securely connected, push them back into the box and replace the cover. Do not over tighten cover screws (torque to 8 in.lb max {0.9 N.m.}). Connect the bonding conductor to the bonding lug on the side of the spa pack (a grounded electrode conductor should be used to connect the equipment grounding conductors).

## Electrical wiring

### Electrical wiring: CE/AS/NZS models

Refer to wiring diagram in the enclosure box lid for more information.



#### Warning!

in.yj.ce models must always be connected to a circuit protected by a Residual-Current Device (RCD) having a rated operating residual-current not exceeding 30 mA.

Correct wiring of the electrical service box, RCD, and pack terminal block is essential!  
Check your electrical code for local regulations. Only copper wire should be used, never aluminum.

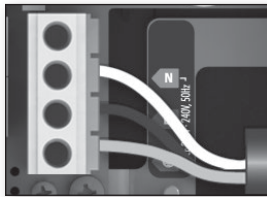

**230 V (3 wires)**

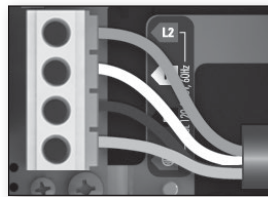

**230 V (4 wires-dual phase)**

Insert each wire into the appropriate socket of the main entry terminal block according to the color code indicated on the sticker. Use a flat screwdriver to tighten the screws on the terminal.

After making sure wires are securely connected, push them back into the box and replace the cover. Do not over tighten cover screws (torque to 8 in.lb max {0.9 N.m.}).

Connect the bonding conductor to the bonding lug on the side of the spa pack (a grounded electrode conductor should be used to connect the equipment grounding conductors).

## Controller power up

### Start up of your control system

To perform the control system start up, refer to the manual:

[Start up guide and basic configuration](#)



---

## Compatible keypads

### List of compatible keypads for the in.yj control system

For more information on the compatible keypads for your control system refer to the corresponding Techbook.



[in.k300 main keypad](#)  
LCD display, 4 keys



[in.k330 main keypad](#)  
Color LCD display, 5 keys



[in.k450 main keypad](#)  
ACL display, 7 keys



[in.k500 main keypad](#)  
Color LCD display, 7 keys



[in.k800 main keypad](#)  
Color LCD display, 10 keys



[in.k1000 main keypad](#)  
[in.k1000+ main keypad](#)  
Color LCD capacitive  
touchscreen display



[in.k1001 main keypad](#)  
[in.k1001+ main keypad](#)  
Color LCD capacitive  
touchscreen display

## Troubleshooting information for your control system

You come across a problem with your control system, for the troubleshooting of your control system, refer to the manual:

[Troubleshooting guide](#)



## Specifications

### Model

in.yj-2-V3: 2 outputs

in.yj-3-V3: 3 outputs

### Environmental ratings

<b>Operating temperature:</b>	32°F (0°C) to 140°F (60°C)
<b>Storage temperature:</b>	-13°F (-25°C) to 185°F (85°C)
<b>Humidity:</b>	Up to 85% RH, non condensing
<b>Level of waterproofing:</b>	IPx5 for CE/AS/NZS & CSA Enclosure #2

### Mechanical

#### in.yj

<b>Weight:</b>	3.1 lb (1.41 kg)
<b>Dimensions (W x H x D):</b>	12.08" x 7.38" x 3.74" (307 x 187 x 95 mm)

#### heat.wav

<b>Weight:</b>	4.65 lb (2.1 kg)
<b>Dimensions (W x H x D):</b>	19.58" x 4.94" x 3.92" (497 x 125 x 100 mm)

### in.yj North American electrical specifications\*1

**Input rating (in.yj-3):** 120/240 V nominal (+5/-10%), 60 Hz  
(2 lines required with neutral) 40 A Max.

**Input rating (in.yj-2):** 120/240 V nominal (+5/-10%), 60 Hz  
32 A Max (2 lines required with neutral)  
**or:**  
120 V nominal only (+5/-10%), 60 Hz  
(single line with neutral) 16 A Max.

#### Heat.wav rating:

**Voltage:** 120 V or 240 V, 1 kW at 120 V  
**Wattage:** 4 kW at 240 V, 1 kW at 120 V  
**Flow rate:** Minimum of 18 GPM (68,1 LPM) is required

Device*2	Voltage*3	Maximum current
Pump 1 (2-spd)	120 or 240 V	15 FLA/60 LRA (inrush)
Pump 2 (1-spd)*4	120 or 240V	15 FLA/60 LRA (inrush)
O3*5	120 or 240 V	3 FLA/6 A
Direct out 1	120 or 240 V	5 A (always on)
Light output	12 Vdc	1 AMP (12W Light bulb)*6
RGB LEDs output*7		51 Leds Max (1 AMP Max)*6

### North American Standards

UL 1563	FCC part 15 (2018) subpart B	ICES-003 (2016)
UL File: E182156	CAN/CSA C22.2 No. 218.1 -13	



\*1 Certain current limits may apply. Please talk to your customer service representative for more information.

\*2 Total of Pump 1, O3 and Direct out should not exceed 16 A for north american models.

\*3 The output voltage is selectable only if input supply voltage is 120/240 V.

\*4 Only available on in.yj-3.

\*5 The ozonator is connected in parallel with the Pump 1 low speed, therefore they cannot be controlled independently.

\*6 The maximum current on both light and RGB LEDs output may not exceed 1A.

\*7 Compatible with the in.lu.me Gecko LED Module. Please talk to your customer service representative for more information.

## Specifications

### in.yj European and international (CE/AS/NZS) electrical specifications\*1

<b>Input rating (in.yj-3):</b>	220-240 V nominal (+5/-10%), 50-60 Hz, (1 line required with neutral), single-phase system 40 A Max. <b>or:</b> 220-240 V nominal with neutral (+5/-10%), 50-60 Hz, (2 lines required with neutral), dual-phase system 20 A Max per phase.
<b>Input rating (in.yj-2):</b>	220-240 V nominal (+5/-10%), 50-60 Hz, (1 line required with neutral), single-phase system 32 A Max.
<b>Heat.wav rating:</b>	
<b>Voltage:</b>	220/240 V, 50/60 Hz
<b>Wattage:</b>	4 kW at 220 - 240 V
<b>Flow rate:</b>	Minimum of 18 GPM (68,1 LPM) is required

Device*2	Voltage*3	Maximum current
Pump 1 (2-spd)	220 V - 240 V	15 FLA/60 LRA (inrush)
Pump 2 (1-spd)*4	220 V - 240 V	15 FLA/60 LRA (inrush)
O3*5	220 V - 240 V	3 FLA/6 A
Direct out 1	220 V - 240 V	5 A (always on)
Light output	12 Vdc	1 AMP (6W Light bulb)*6
RGB (in.lu.me) output*7		51 in.lu.me's Max (1 AMP Max)*6

### European and international standards (CE/AS/NZS)

IEC 60335-2-60:2017  
IEC 60335-1:2010 + AMD1:2013 + AMD2:2016



AS/NZS 60335.2.60:2006  
AS/NZS 60335.1:2011 + A1:2012 + A2:2014 + A3:2015

EN 55014-1 (2017)  
EN 55014-2 (2015)

\*1 Certain current limits may apply. Please talk to your customer service representative for more information.

\*2 Total of Pump 1, O3, heater, and Direct out should not exceed 32 A for CE/AS/NZS version.

\*3 The output voltage for the CE/AS/NZS version will reflect the input voltage, typically 230 V.

\*4 Only available on in.yj-3

\*5 The ozonator is connected in parallel with the Pump 1 low speed, therefore they cannot be controlled independently.

\*6 The maximum current on both Light and RGB LEDs output may not exceed 1A.

\*7 Only compatible with the in.lu.me Gecko LED Module. Please talk to your customer service representative for more information.



9919-101592-B  
Rev. 08-2021

© Groupe Gecko Alliance inc., 2021  
All trademarks or registered trademarks  
are the property of their respective owners.

Gecko Alliance  
450 des Canetons, Quebec City (Qc), G2E 5W6 Canada, 1.800.78.GECKO  
[www.geckoalliance.com](http://www.geckoalliance.com)

Printed in Canada