

SWIMMING POOL HEAT PUMP

User and Service Manual



**Swimming Pool Heat Pump
User and Service Manual**

INVERBOOST INVERTER

Regulation (EU) n° 517/2014 of 16/04/14 on fluorinated greenhouse gases and repealing

Regulation (EC) n° 842/2006

Leak checks

1. Operators of equipment that contains fluorinated greenhouse gases in quantities of 5 tons of CO₂, equivalent or more and not contained in foams shall ensure that the equipment is checked for leaks.

2. For equipment that contains fluorinated greenhouse gases in quantities of 5 tons of CO₂ equivalent or more, but of less than 50 tons of CO₂ equivalent: at least every 12 months.

Picture of the equivalence CO₂

1. Load in kg and Tons amounting CO₂.

Load and Tons amounting CO ₂	Frequency of test
From 7 at 75 kg load = from 5 at 50 Tons	Each year

Concerning the Gas R32, 7.40kg amounting at 5 tons of CO₂, commitment to check each year.

Training and certification

1. The operator of the relevant application shall ensure that the relevant personnel have obtained the necessary certification, which implies appropriate knowledge of the applicable regulations and standards as well as the necessary competence in emission prevention and recovery of fluorinated greenhouse gases and handling safety the relevant type and size of equipment.

Record keeping

1. Operators of equipment which is required to be checked for leaks, shall establish and maintain records for each piece of such equipment specifying the following information:

- a) The quantity and type of fluorinated greenhouse gases installed;
- b) The quantities of fluorinated greenhouse gases added during installation, maintenance or servicing or due to leakage;
- c) Whether the quantities of installed fluorinated greenhouse gases have been recycled or reclaimed, including the name and address of the recycling or reclamation facility and, where applicable, the certificate number;
- d) The quantity of fluorinated greenhouse gases recovered
- e) The identity of the undertaking which installed, serviced, maintained and where applicable repaired or decommissioned the equipment, including, where applicable, the number of its certificate;
- f) The dates and results of the checks carried out;
- g) If the equipment was decommissioned, the measures taken to recover and dispose of the fluorinated greenhouse gases.

2. The operator shall keep the records for at least five years, undertakings carrying out the activities for operators shall keep copies of the records for at least five years.

INDEX

1. Specifications
2. Dimension
3. Installation and Connection
4. Adjust the by-pass Kit
5. Display Controller Operation
6. Malfunction and Trouble Shooting
7. Electrical Wiring
8. Maintenance
9. Exploded View

Thank you for using INVERBOOST INVERTER swimming pool heat pump for your pool heating, it will heat your pool water and keep the constant temperature when the air ambient temperature is at -20 to 43°C



ATTENTION: This manual includes all the necessary information with the use and the installation of your heat pump.

The installer must read the manual and attentively follow the instructions in implementation and maintenance.

The installer is responsible for the installation of the product and should follow all the instructions of the manufacturer and the regulations in application. Incorrect installation against the manual implies the exclusion of the entire guarantee.

The manufacturer declines any responsibility for the damage caused with the people, objects and of the errors due to the installation that disobey the manual guideline. Any use that is without conformity at the origin of its manufacturing will be regarded as dangerous.

WARNING: Please always empty the water in heat pump during winter time or when the ambient temperature drops below 0°C, or else the Titanium exchanger will be damaged because of being frozen, in such case, your warranty will be lost.

WARNING: Please always cut the power supply if you want to open the cabinet to reach inside the heat pump, because there is high voltage electricity inside.

WARNING: Please well keep the display controller in a dry area, or well close the insulation cover to protect the display controller from being damaged by humidity.

1. Specification

Model		UX11Csi32	UX14Csi32	UX17Csi32
* Performance at Air 28°C Water 28°C Humidity 80%				
Turbo Heating Capacity	kW	11.0	14.0	17.0
Smart Heating Capacity	kW	10.0	11.0	14.0
Power consumption	kW	1.55-0.17	1.97-0.22	2.39-0.27
C.O.P.		16-7.4	16-7.1	16-7.2
C.O.P. in Turbo Mode		7.4	7.1	7.2
C.O.P. at 50% capacity		11.8	11.0	11.8
* Performance at Air 15°C Water 26°C Humidity 70%				
Turbo Heating Capacity	kW	8.5	9.5	12.0
Smart Heating Capacity	kW	7.0	8.0	10.5
Power consumption	kW	1.67-0.26	1.90-0.29	2.31-0.37
C.O.P.		8.2-5.1	8.21-5	8.5-5.2
C.O.P. in Turbo Mode		5.1	5.0	5.2
C.O.P. at 50% capacity		7.1	7.0	7.8
*General Date				
Compressor type		Inverter compressor		
Voltage		220-240V/50Hz/1PH		
Rated current	A	6.9	8.7	10.6
Max current	A	10.5	13.5	15.5
Minimum fuse	A	12.0	15.0	16.0
Advised water flux	m ³ /h	3.7	4.0	5.0
Water pressure drop	Kpa	12.0	14.0	15.0
Heat exchanger		Twist Titanium exchanger		
Water connection	mm	50		
Fan quantity		1		
Ventilation type		Horizontal		
Noise level(10m)	dB(A)	17.8-26.2	21.7-26.7	22.6-28.1
Noise level(1m)	dB(A)	36-46.2	38-47.6	39.5-49.8
* Dimension/ Weight				
Net weight	kg	73	78	98
Gross weight	kg	78	83	113
Net dimension	mm	1028*441*685	1028*441*685	1073*492*886
Packing dimension	mm	1095*525*830	1095*525*830	1140*555*1030

Model		UX21Csi32	UX30Csi32T	UX35Csi32T
* Performance at Air 28°C Water 28°C Humidity 80%				
Turbo Heating Capacity	kW	21.0	30.0	35.0
Smart Heating Capacity	kW	18.0	25.0	30.0
Power consumption	kW	2.96-0.33	4.17-0.47	4.93-0.55
C.O.P.		16-7.1	16-7.1	16-7.1
C.O.P. in Turbo Mode		7.1	7.1	7.1
C.O.P. at 50% capacity		11.2	11.2	11.2
* Performance at Air 15°C Water 26°C Humidity 70%				
Turbo Heating Capacity	kW	15.5	20.0	24.0
Smart Heating Capacity	kW	13.5	18.0	22.0
Power consumption	kW	3.04-0.47	3.85-0.61	4.62-0.73
C.O.P.		8.3-5.1	8.2-5.2	8.2-5.2
C.O.P. in Turbo Mode		5.1	5.2	5.2
C.O.P. at 50% capacity		7.4	7.2	7.2
*General Date				
Compressor type		Inverter compressor		
Voltage		220-240V/50Hz/1PH	380V/50Hz/3PH	
Rated current	A	13.1	7.5	8.8
Max current	A	19.5	12.0	14.0
Minimum fuse	A	22	15	17
Advised water flux	m ³ /h	6.0	10.0	15.0
Water pressure drop	Kpa	15	20	25
Heat exchanger		Twist Titanium exchanger		
Water connection	mm	50		
Fan quantity		1	2	2
Ventilation type		Horizontal		
Noise level(10m)	dB(A)	22.9-30.6	23.2-32.4	23.4-32.8
Noise level(1m)	dB(A)	40-51	42-51.8	42.8-52
* Dimension/ Weight				
Net weight	kg	117	130	135
Gross weight	kg	135	148	150
Net dimension	mm	1073*492*886	1130*500*1410	1130*500*1410
Packing dimension	mm	1140*555*1030	1185*565*1555	1185*565*1555

* Above data may be modified without notice.

2. Dimension

UX11Csi32/UX14Csi32

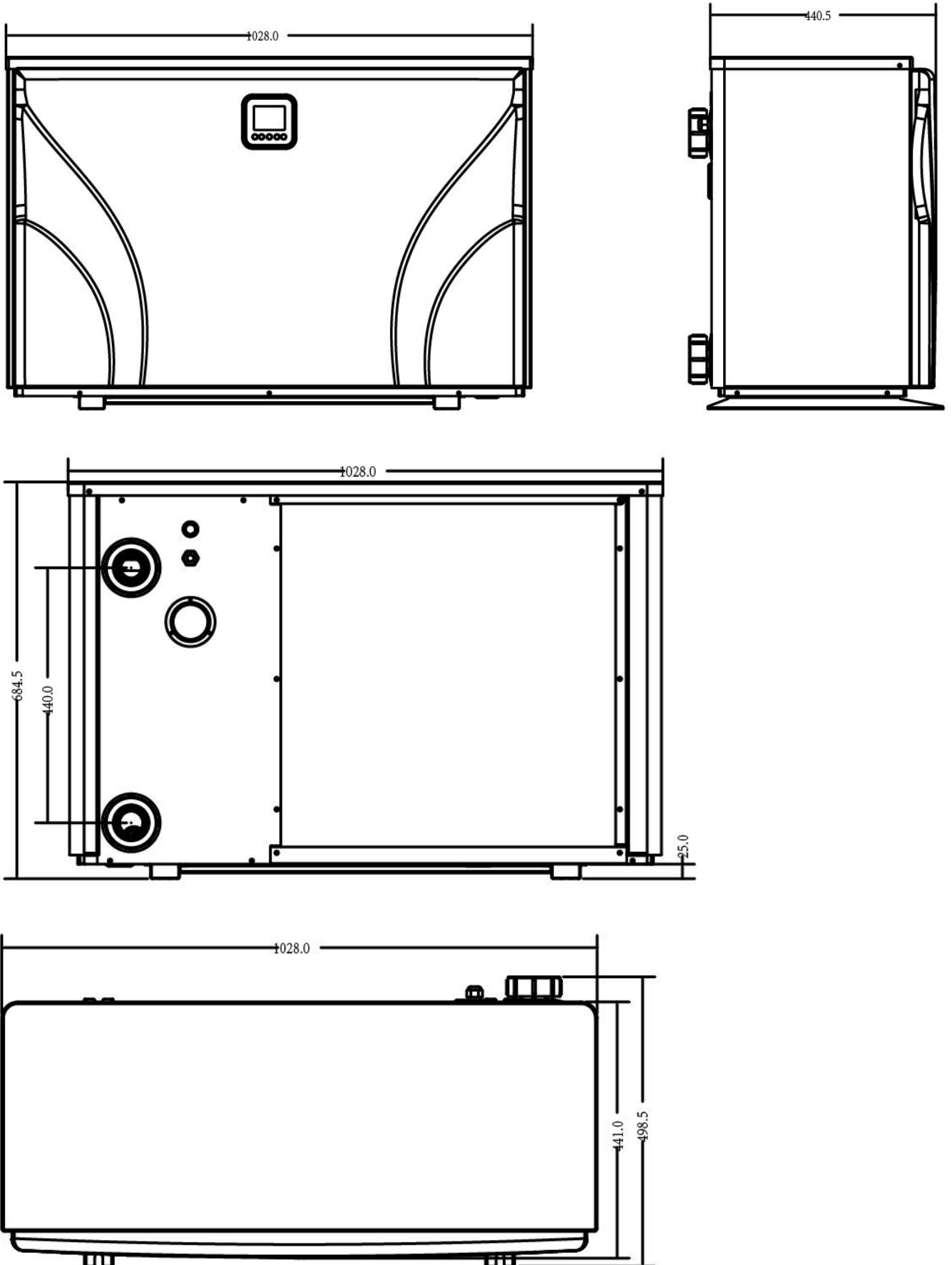

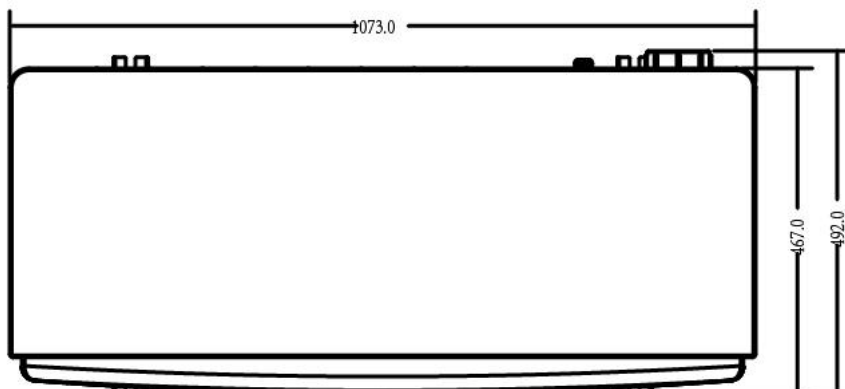
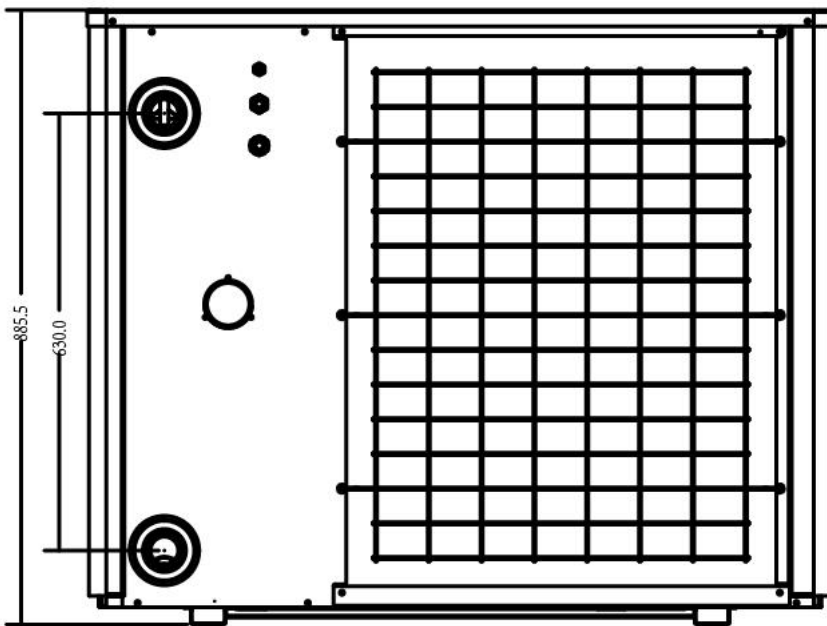
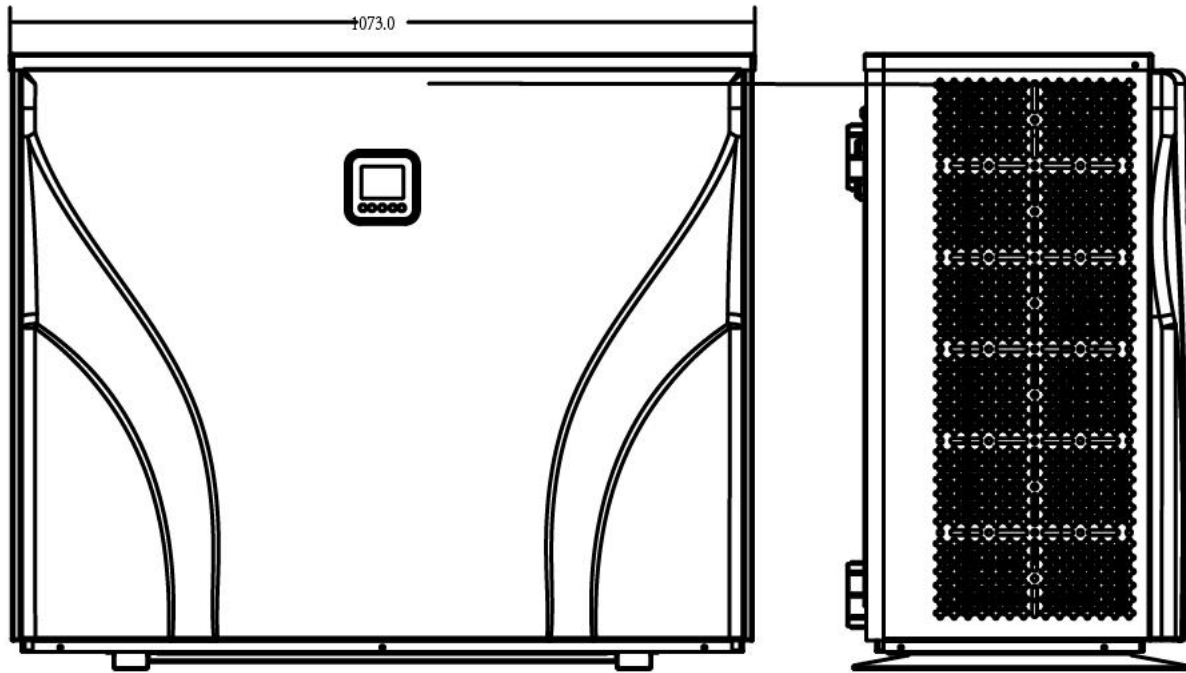

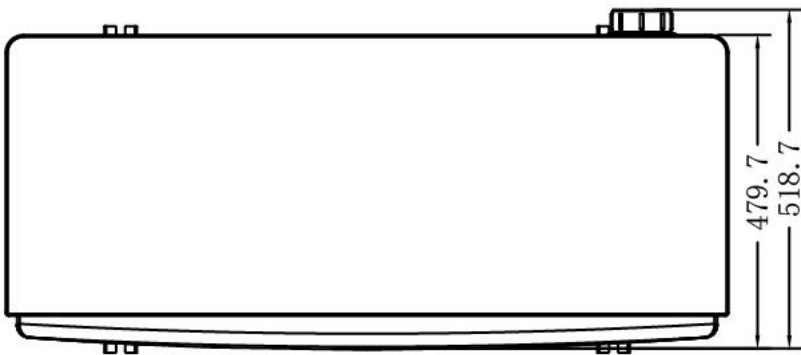
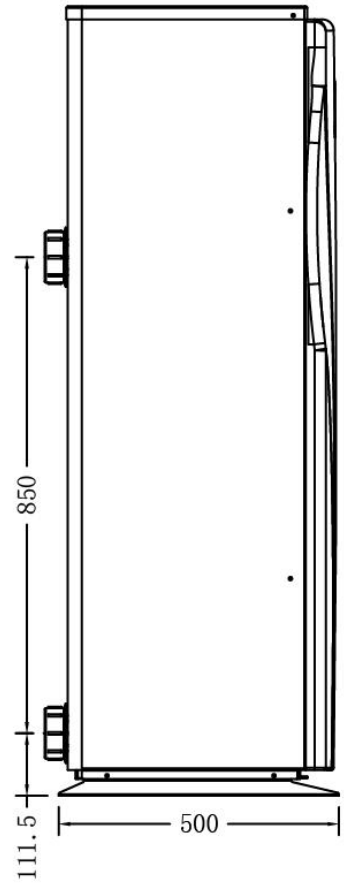
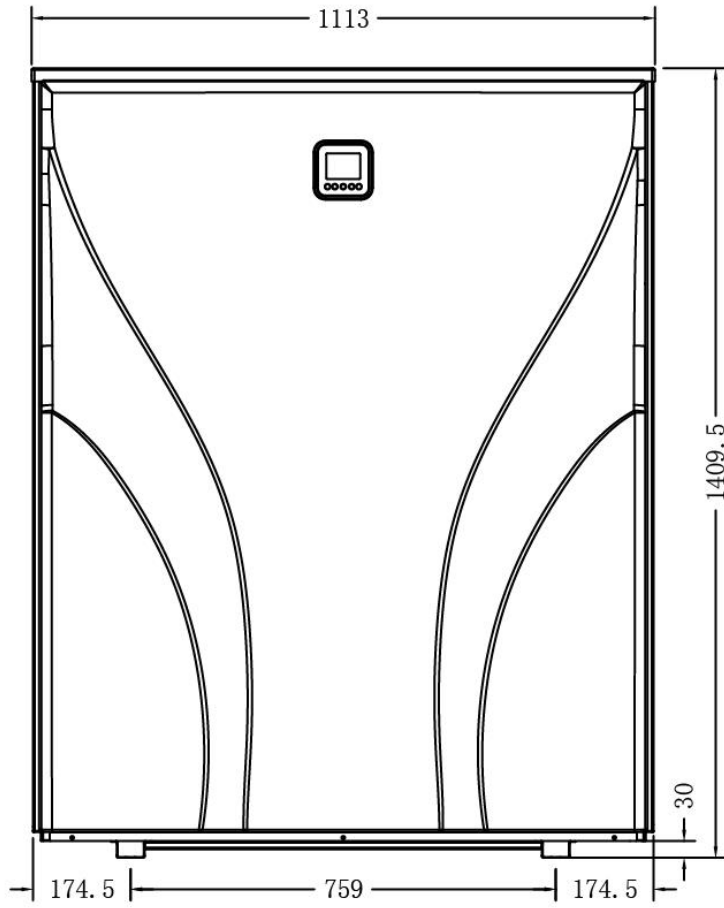

UX30Csi32T/UX35Csi32T



Unit: mm

3. Installation and connection

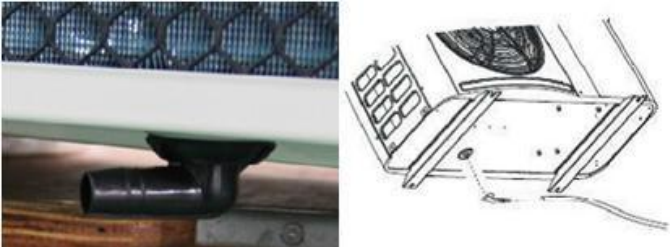
3.1 Installation

	<p>Anti-vibration bases</p> <ol style="list-style-type: none">1. Take out 4 Anti-vibration bases2. Put them one by one on the bottom of machine like the picture.
	<p>Draining jet</p> <ol style="list-style-type: none">1. Install the draining jet under the bottom panel2. Connect with a water pipe to drain out the water. <p>Note: Lift the heat pump to install the jet. Never overturn the heat pump, it could damage the compressor.</p>
	<p>Water Inlet & outlet junction</p> <ol style="list-style-type: none">1. Use the pipe tape to connect the water Inlet & outlet junction onto the heat pump2. Install the two joints like the picture shows3. Screw them onto the water Inlet & outlet junction
	<p>Mains Cable wiring</p> <ol style="list-style-type: none">1. Open the cover of the electric box inside the machine2. Connect the cables in the correct terminal according to electric diagram.

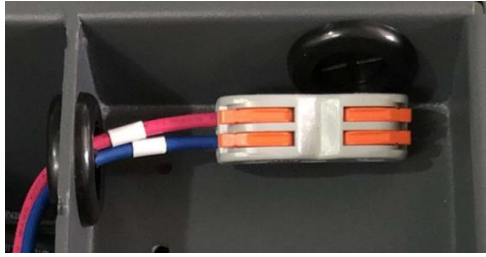

Filtration pump wiring (Dry contact)

1. Open the cover of the electric box inside the machine
2. Connect the cables in the correct terminal according to electric diagram.

Connection to pilot the water pump

--	--	--

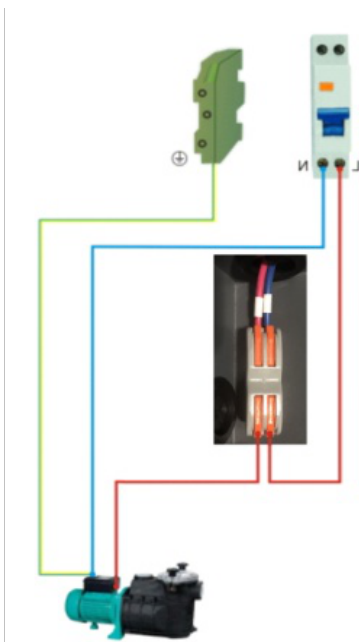

Notes

The factory supplies only the heat pump. All other components, including a bypass if necessary, must be provided by the user or the installer.

Attention:

Please observe the following rules when installing the heat pump:

1. Any addition of chemicals must take place in the piping located **downstream** from the heat pump.
2. Install a bypass if the water flow from the swimming pool pump is more than 20% greater than the allowable flow through the heat exchanger of the heat pump.
3. Install the heat pump above the water level of the swimming pool.

4. Always place the heat pump on a solid foundation and use the included rubber mounts to avoid vibration and noise.
5. Always hold the heat pump upright. If the unit has been held at an angle, wait at least 24 hours before starting the heat pump.

3.2 Heat pump location

The unit will work properly in any desired location as long as the following three items are present:

1. Fresh air
2. Electricity
3. Swimming pool filters

The unit may be installed in virtually any **outdoor** location as long as the specified minimum distances to other objects are maintained (see drawing below). Please consult your installer for installation with an indoor pool. Installation in a windy location does not present any problem at all, unlike the situation with a gas heater (including pilot flame problems).

ATTENTION: Never install the unit in a closed room with a limited air volume in which the air expelled from the unit will be reused, or close to shrubbery that could block the air inlet. Such locations impair the continuous supply of fresh air, resulting in reduced efficiency and possibly preventing sufficient heat output.

See the drawing below for minimum dimensions.

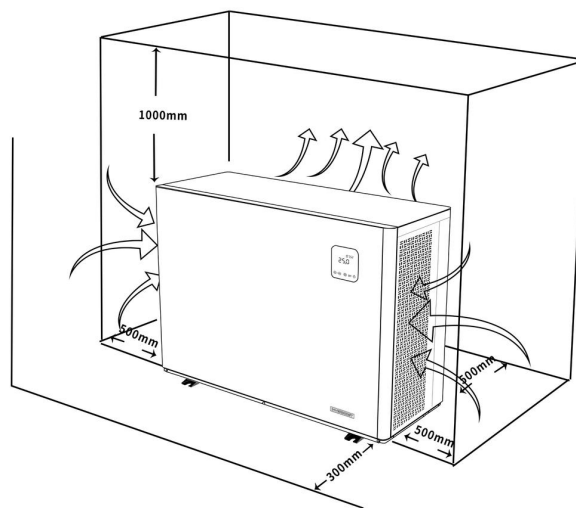

3.3 Distance from your swimming pool

The heat pump is normally installed within a perimeter area extending 7.5 m from the swimming pool. The greater the distance from the pool, the greater the heat loss in the pipes. As the pipes are mostly underground, the heat loss is low for distances up to 30 m (15 m from and to the pump; 30 m in total) unless the ground is wet or the groundwater level is high. A rough estimate of the heat loss per 30 m is 0.6 kWh (2,000 BTU) for every 5 °C difference between the water temperature in the pool and the temperature of the soil surrounding the pipe. This increases the operating time by 3% to 5%.

3.4 Check-valve installation

Note: If automatic dosing equipment for chlorine and acidity (pH) is used, it is essential to protect the heat pump against excessively high chemical concentrations which may corrode the heat exchanger. For this reason,

equipment of this sort must always be fitted in the piping on the **downstream** side of the heat pump, and it is recommended to install a check-valve to prevent reverse flow in the absence of water circulation. Damage to the heat pump caused by failure to observe this instruction is not covered by the warranty.

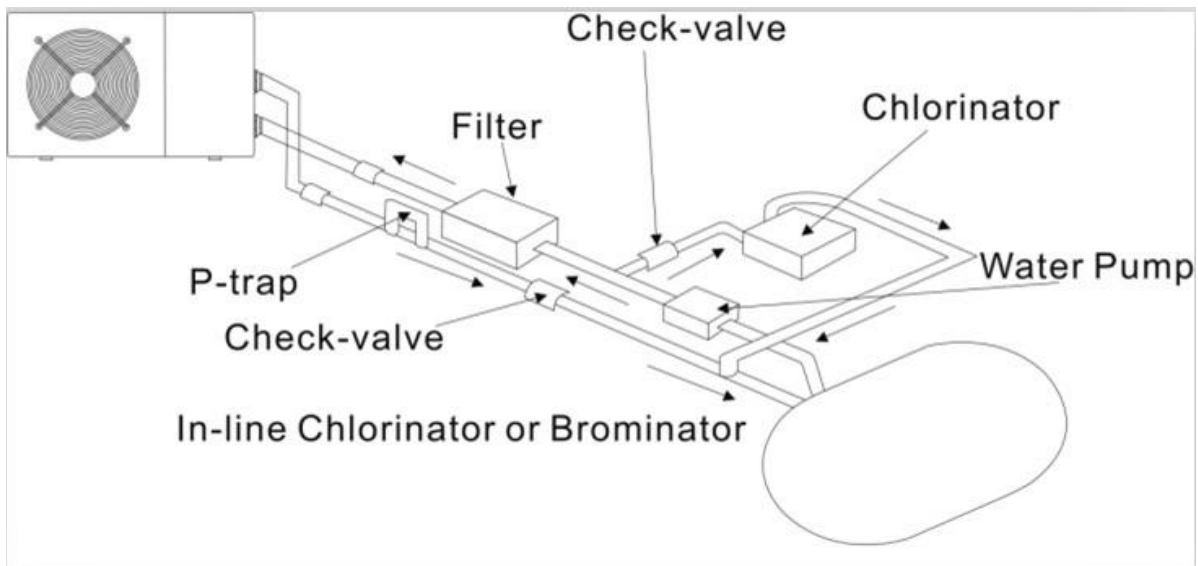

3.5 Typical arrangement

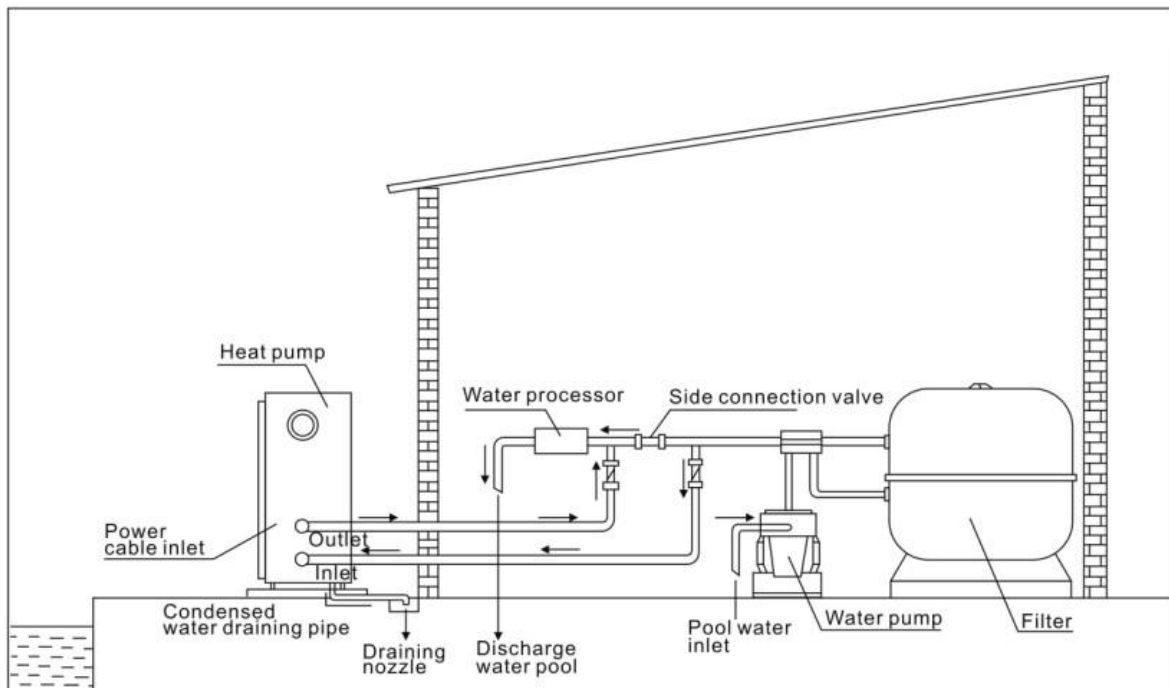

Note: This arrangement is only an illustrative example.

3.6 Initial operation

Note: In order to heat the water in the pool (or hot tub), the filter pump must be running to cause the water to circulate through the heat pump. The heat pump will not start up if the water is not circulating.

After all connections have been made and checked, carry out the following procedure:

1. Switch on the filter pump. Check for leaks and verify that water is flowing from and to the swimming pool.
2. Connect power to the heat pump and press the On/Off button  on the electronic control panel. The unit will start up after the time delay expires (see below).
3. After a few minutes, check whether the air blowing out of the unit is cooler.
4. When turn off the filter pump , the unit should also turn off automatically , if not, then adjust the flow switch.
5. Allow the heat pump and the filter pump to run 24 hours a day until the desired water temperature is reached. The heat pump will stop running at this point. After this, it will restart automatically (as long as the filter pump is running) whenever the swimming pool water temperature drops 2 degree below the set temperature.

Depending on the initial temperature of the water in the swimming pool and the air temperature, it may take several days to heat the water to the desired temperature. A good swimming pool cover can dramatically reduce the required length of time.

3.7 Condensation

The air drawn into the heat pump is strongly cooled by the operation of the heat pump for heating the pool water, which may cause condensation on the fins of the evaporator. The amount of condensation may be as much as several liters per hour at high relative humidity. This is sometimes mistakenly regarded as a water leak.

4. Adjusting the bypass kit

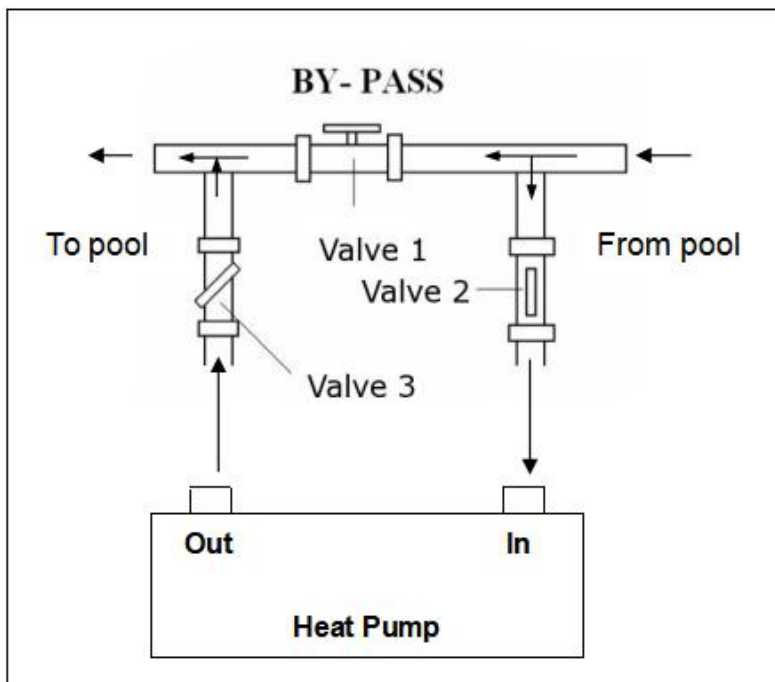

Use the following procedure to adjust the bypass:

- fully open all three valves
- slowly close valve 1 until the water pressure is increased by approximately 100 to 200 g
- Close valve 3 approximately half-way to adjust the gas pressure in the cooling system
- If the display shows "ON" or error code EE03, close step by step the valve 2, to increase water flow and stop when the code disappears.

Optimal operation of the heat pump occurs when the cooling gas pressure is 22 ± 2 bar.

This pressure can be read on the pressure gauge next to the control heat pump panel. Under these conditions the water flow through the unit is also optimal.

Note: Operation without a bypass or with improper bypass adjustment may result in sub-optimal heat pump operation and possibly damage to the heat pump, which renders the warranty null and void.

Water Flow Switch:

It is equipped with a flow switch for protecting the HP unit running with adequate water flow rate. It will turn on when the pool pump runs and shut it off when the pump shuts off. If the pool water level higher than 1 m above or below the heat pump's automatic adjustment knob, your dealer may need to adjust its initial start-up.

Time delay - The heat pump has a built-in 3-minute start-up delay to protect the circuitry and avoid excessive contact wear. The unit will restart automatically after this time delay expires. Even a brief power interruption will trigger this time delay and prevent the unit from restarting immediately. Additional power interruptions during this delay period do not affect the 3-minute duration of the delay.

5. Display Controller Operation

5.1. Guide for operation





When the heat pump connects to the power, the display shows a code for 3 seconds which indicates the heat pump model.

5.2 The keys and their operations

5.2.1 button

Press  to start the heat pump unit, the display shows the desired water temperature for 5 seconds, then shows the inlet water temperature and the operation mode.



Press  to stop the heat pump unit and show "OFF"

Notice : During the parameter checking and setting, press the  to quick-exit and save the current setting .

Press  again to turn on/off the machine.



5.2.2 and button

Lock/unlock the display:

Hold  and  for 5 seconds to lock/Unlock the display.

The display will lock automatically after 30s of standby. (when the display is locked, the "locker " icon is lighted ON)

Water temperature setting:

Press  or  to set the water temperature directly.

Heating mode and Auto mode setting range: 6-41°C

Cooling mode setting range: 6-35°C

5.2.3  button working mode

Press  to change the working mode, Turbo, Smart and silent .The default mode is smart mode.

While you choose the **Turbo**, the word "Turbo" will be lit, the heat pump will operate in 'Full output' only. Choose the **Smart**, the word "Smart" will be lit, the heat pump will operate in 'Medium and Full output'. Choose the **Silent**, the word "Silent" will be lit, heat pump will operate in 'Medium and Small output'.

5.2.4  button mode

Press  for 5S to switch the heating mode , cooling mode  and auto mode .

Remark: When defrosting, the heating symbol will flash.

Operation logic of Auto Mode:

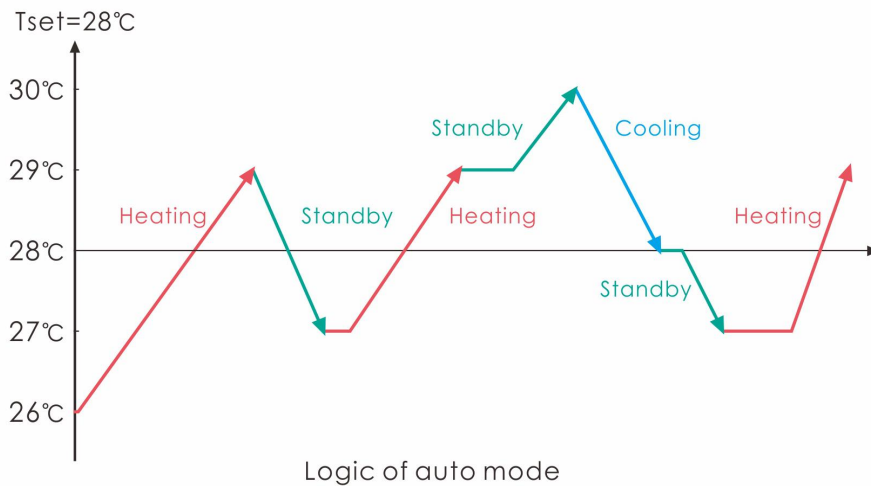

5.2.5 Parameter checking



Code	Condition	Scope	Remark
d0	IPM mould temperature	0-120°C	Real testing value
d1	Inlet water temp.	-9°C~99°C	Real testing value
d2	Outlet water temp.	-9°C~99°C	Real testing value
d3	Ambient temp.	-30°C~70°C	flash if Real value<-9
d4	Frequency limitation code	0,1,2,4,8,16	Real testing value
d5	Piping temp.	-30°C~70°C	flash if Real value<-9
d6	Gas exhaust temperature	0°C~C5°C(125°C)	Real testing value
d7	Step of EEV	0~99	N*5
d8	Compressor running frequency	0~99Hz	Real testing value
d9	Compressor current	0~30A	Real testing value
d10	Current fan speed	0-1200 (rpm)	Real testing value
d11	Error code for last time	All error code	

Remark:

d4: Frequency limitation code,

0: No frequency limit;



1:Coil pipe temperature limit;

2: Overheating or overcooling frequency limit; 4:Drive Current frequency limit;

8:Drive voltage frequency limit;

16:Drive high temperature frequency limit

5.2.6 Parameter setting

Press , then press  to choose P0-P18 value, and press  again to enter the setting interface, in which parameter will flash.

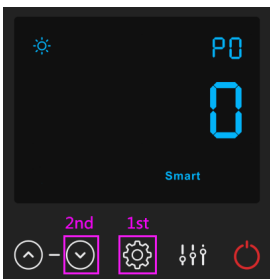





Code	Name	Scope	Default	Remark
P0	Mandatory defrosting	0-1	0	0: Default normal operation 1: mandatory defrosting.
P1	Working mode	0-1	1	1:Heating mode, 0:cooling mode,
P2	Timer on/off	0-1	0	1 Timer on/off is under function, 0 Timer on/off is out of function (The setting of P5 and P6 won't work)
P3	Water pump	0-1	0	1:Always running; 0:Depends on the running of compressor
P4	Current time	HH:MM	00: 00	0-23:0-59
P5	Timer on	HH:MM	00: 00	0-23:0-59
P6	Timer off	HH:MM	00: 00	0-23:0-59
P7	Water temp. calibration	-9~9	0	Default setting: 0
P14	Restore to factory settings	0-1	0	1-Restore to factory settings, 0- default (restore P0, P1, P2, P3, P5, P6, P7, P8, P9, 10, P11 to factory setting)
P16	Product code	/	/	Depends on the machine
P18	Mode	0-1	0	1—Heating only, 0—Heating/Cooling/Auto mode

Note:

- 1). Long press  for 20s to set P14, P16, P18.
- 2). P8,P9,P10,P11,P19,P20 parameter is only for factory setting.

5.2.7 System reset function

Press  , then press  to choose P14, and enter into the value setting interface by long press

 for 20s, in which parameter will flash. Press  or  to set the value 1, finally press  to save settings.

5.2.8

Symbol of TIMER ON, the light will be on when the value of P2 is 1, which means TIME ON & OFF function is working. Then set the current time(Parameter P4), TIMER ON (Parameter P5) and TIMER OFF (Parameter P6). All the symbols (except symbol ) on the display will be off when TIMER is OFF.

Note: The symbol  keeps on when restart the heat pump after TIME OFF, unless the value of P2 is set to 0.

5.2.9 System filtration pilot function

Option 1; P3=0 Filtration pump is related to heat pump operation to start and stop.

Filtration pump starts 60s before compressor, filtration pump start 30s and then the water flow switch detect flow. Before the heat pump enters into Standby mode, the compressor stops first and after 5 minutes filtration pump stops.

	Condition	Example	Water pump working logic	
Heating mode	P3=0, T1≥Tset-0.5°C last for 30 minutes	P3=0, T1≥27.5°C last for 30 minutes	1. Then it enters into standby mode for 1 hour (It will not restart except turn it on manually.)	2. After 1 hour, the filtration pump will restart for 5 minutes. If the T1≤27°C the heat pump will start to work until T1≥27.5°C and last for 30 minutes to go into standby
Cooling mode	P3=0, T1≤Tset+0.5°C last for 30 minutes	P3=0, T1≤28.5°C last for 30 minutes	1. Then it enters into standby mode for 1 hour (It will not restart except turn it on manually.)	2. After 1 hour, the filtration pump will restart for 5 minutes. If it tests T1≥29°C the heat pump will start to work until T1≤28.5°C and last for 30 minutes to go into standby

Option 2; P3=1 Filtration pump is always on, P2=0 the timer function is no active

Under condition P3=1, when T1≥Tset+1°C (T1≥29°C) last for 3 minutes, heat pump will be in standby, while filtration pump is always on.

Under option 2, with activation of the timer; P2=1 to start and stop the filtration pump according the programming of the P4 (time), P5 (timer ON) and P6 (timer OFF)

Condition for the heat pump start, timer ON actives;

When the timer reaches the set time of TIMER ON, the filtration pump will start and after 5 minutes the heat pump start. The heat pump stays in stop if the water in temperature is ≥ Tset+1°C before the TIMER OFF, the filtration is still activated.

Condition to stop the heat pump, timer OFF actives;

When the timer reaches the set time of the TIMER OFF, the heat pump will stop and after 5 minutes the filtration pump stops.

If heat pump is turned ON/OFF manually, the filtration pump will start and stop accordingly.

NOTE :

Tset = Tsetting water temperature

For example : Tset = 28°C Tsetting water temperature in your pool heat pump

Tset-0.5 = less 0.5°C than Tsetting temperature, Tset- 0.5 = 28-0.5=27.5°C

Tset+0.5= more 1°C than Tsetting temperature, Tset+ 0.5 = 28+0.5=28.5°C

5.3 Heating operation logic

Working status		Working mode	Water in temperature-T1	For example, water in temperature-T1	Heat pump working level
1	Start-up of heat pump	When you select the "Smart working mode "	$T1 < Tset-1$	$T1 < 27^{\circ}C$	Powerful mode-frequency F9
2			$Tset-1 \leq T1 < Tset$	$27^{\circ}C \leq T1 < 28^{\circ}C$	Frequency: F9 -F8-F7,...,-F2
3			$Tset \leq T1 < Tset+ 1$	$28^{\circ}C \leq T1 < 29^{\circ}C$	Silent mode-frequency F2
4			$T1 \geq Tset+1$	$T1 \geq 29^{\circ}C$	HP will be in Standby, stop working until the water temperature drops to less 28°C
5		When you select the "Silent working mode".	$T1 < Tset$	$T1 < 28^{\circ}C$	Smart mode -frequency F5.
6			$Tset \leq T1 < Tset+1$	$28^{\circ}C \leq T1 < 29^{\circ}C$	Silent mode-frequency F2/F1.
7			$T1 \geq Tset+1$	$T1 \geq 29^{\circ}C$	HP will be in Standby, stop working until the water temperature drops to less 28°C
8		When you select the "Powerful working mode."	$T1 < Tset+1$	$T1 < 29^{\circ}C$	Powerful mode-frequency F10/F9
9			$T1 \geq Tset+1$	$T1 \geq 29^{\circ}C$	HP will be in Standby, stop working until the water temperature drops to less 28°C
10	Re-start to heat water in standby status	When HP is working at " Smart mode"	$T1 \geq Tset$	$T1 \geq 28^{\circ}C$	Standby
11			$Tset > T1 \geq Tset-1$	$28^{\circ}C > T1 \geq 27^{\circ}C$	Silent-frequency F2
12			$Tset-1 > T1 \geq Tset-2$	$27^{\circ}C > T1 \geq 26^{\circ}C$	Frequency: F2 -F3-F4,...,-F9
13			$T1 < Tset-2$	$< 26^{\circ}C$	Powerful-frequency F9
14		When HP is working at " Silent mode"	$\geq Tset$	$\geq 28^{\circ}C$	Standby
15			$Tset > T1 \geq Tset-1$	$28^{\circ}C > T1 \geq 27^{\circ}C$	Silent mode-frequency F2/F1
16			$T1 < Tset-1$	$T1 < 27^{\circ}C$	Smart -frequency F5
17	When HP is working at " Powerful mode"	$T1 < Tset-1$	$T1 < 27^{\circ}C$	Powerful -frequency F10/F9	

5.4 Cooling operation logic

Working status	Working mode	Water in temperature	For example, water in temperature	Heat pump working level	
1	When you select the "Smart working mode "	$T1 \leq T_{set}-1$	$T1 \leq 27^{\circ}\text{C}$	Standby.	
2		$T_{set}-1 < T1 \leq T_{set}$	$27^{\circ}\text{C} < T1 \leq 28^{\circ}\text{C}$	Silent mode-frequency F2	
3		$T_{set} < T1 \leq T_{set}+1$	$28 < T1 \leq 29^{\circ}\text{C}$	frequency: F9 -F8-F7,...,- F2	
4		$T1 \geq T_{set}+1$	$T1 \geq 29^{\circ}\text{C}$	Powerful mode-F9	
5	Start-up of heat pump	When you select the "Silent working mode".	$T1 \leq T_{set}-1$	$\leq 27^{\circ}\text{C}$	Standby
6		$T_{set}-1 < T1 \leq T_{set}$	$27^{\circ}\text{C} < T1 \leq 28^{\circ}\text{C}$	Silent mode - frequency F2/F1	
7		$T1 > T_{set}$	$T1 > 28^{\circ}\text{C}$	Smart mode -frequency F5	
8	When you select the "Powerful working mode."	$T1 > T_{set}-1$	$T1 > 27^{\circ}\text{C}$	Powerful mode-frequency F10/F9	
9		$T1 \leq T_{set}-1$	$T1 \leq 27^{\circ}\text{C}$	Standby	
10	Re-start to cool water in standby status	Smart	$T1 \leq T_{set}-1$	$T1 \leq 27^{\circ}\text{C}$	Standby
11			$T_{set} \leq T1 < T_{set}+1$	$28 \leq T1 < 29^{\circ}\text{C}$	Silent- frequency F2
12			$T_{set}+1 \leq T1 < T_{set}+2$	$29 \leq T1 < 30^{\circ}\text{C}$	Frequency: F2 -F3-F4,...,- F9
13			$T1 \geq T_{set}+2$	$T1 \geq 30^{\circ}\text{C}$	Powerful mode -frequency F9
14	Silent	$T_{set} < T1 \leq T_{set}+1$	$28 < T1 \leq 29^{\circ}\text{C}$	Silent mode-frequency F2/F1	
15		$T1 > T_{set}+1$	$T1 > 29^{\circ}\text{C}$	Smart mode-frequency F5	
16	Powerful	$T1 > T_{set}+1$	$T1 > 29^{\circ}\text{C}$	Powerful mode-frequency F10/F9	
17		$T1 \leq T_{set}-1$	$T1 \leq 27^{\circ}\text{C}$	Standby	

6. Malfunction and Trouble Shooting

6.1 Error code display on LED wire controller

Malfunction	Error code	Reason	Solution
Inlet water temperature sensor failure	PP01	1. The sensor in open or short circuit 2. The wiring of sensor is loose	1. Check or change the sensor 2.Re-fix the wiring of the sensors
Outlet water temperature sensor failure	PP02	1. The sensor in open or short circuit 2. The wiring of sensor is loose	1. Check or change the sensor 2.Re-fix the wiring of the sensors
Heating piping sensor failure	PP03	1. The sensor in open or short circuit 2. The wiring of sensor is loose	1. Check or change the sensor 2.Re-fix the wiring of the sensors
Gas return sensor failure	PP04	1. The sensor in open or short circuit 2. The wiring of sensor is loose	1. Check or change the sensor 2.Re-fix the wiring of the sensors
Ambient temperature sensor failure	PP05	1. The sensor in open or short circuit 2. The wiring of sensor is loose	1. Check or change the sensor 2.Re-fix the wiring of the sensors
Exhaust piping sensor failure	PP06	1. The sensor in open or short circuit 2. The wiring of sensor is loose	1. Check or change the sensor 2.Re-fix the wiring of the sensors
Antifreeze protection in Winter	PP07	Ambient temperature or water inlet temperature is too low	Normal protection
Low ambient temperature protection	PP08	1.Beyond the scope of using environment 2. Sensor abnormality	1. Stop using, beyond the scope of using 2.Change the sensor
Piping temperature too high protection under cooling mode	PP10	1. Ambient temperature is too high or the water temperature is too high in cooling mode 2. Refrigeration system is abnormal	1. Check the scope of using 2. Check refrigeration system
T2 water temp. Too low protection under cooling mode	PP11	1. Low water flow 2. T2 temperature sensor abnormal	1. Check water pump and waterway system 2. Change T2 temperature sensor
High pressure failure	EE01	1. Ambient temperature is too high 2. Water temperature is too high 3. Water flow is too low Fan motor speed is abnormal or fan motor has damaged	1. Check the water flow or water pump 2. Check the fan motor 3. Check and repair the piping system
Low pressure failure	EE02	1. EEV has blocked or pipe system is jammed 2. Motor speed is abnormal or motor has damaged 3. Gas leakage	1. Check the EEV and piping system Check the motor 2. Through the high pressure gauge to check the pressure value
Water flow failure	ON	1. Water flow switch is damaged 2. No/ Insufficient water flow.	1. Change the water flow switch 2. Check the water pump or the waterway system
Over heating protection for water temperature (T2) in heating mode	EE04	1. Low water flow 2. Water flow switch is stuck and the water supply is cut off	1. Check the water way system 2. Check the water pump or water flow switch

		3. T2 sensor is abnormal	3. Check T2 sensor or change another one
T6 Exhaust too high protection	EE05	<ol style="list-style-type: none"> 1. Lack of gas 2. Low water flow 3. Piping system has been blocked 4. Exhaust temp. Sensor failure 	<ol style="list-style-type: none"> 1. Check the high pressure gauge, if too low, fill with some gas 2. Check the waterway system and water pump 3. Check the piping system if there was any block 4. Change a new exhaust temp. sensor
Controller failure	EE06	<ol style="list-style-type: none"> 1. Wire connection is not good, or damaged signal wire 2. Controller failure 	<ol style="list-style-type: none"> 1. Check and re-connect the signal wire 2. Change a new signal wire 3. Turn off electricity supply and restart machine 4. Change a new controller
Compressor current protection	EE07	<ol style="list-style-type: none"> 1. The compressor current is too large instantaneously 2. Wrong connection for compressor phase sequence 3. Compressor accumulations of liquid and oil lead to the current becomes larger 4. Compressor or driver board damaged 5. The water flow is abnormal 6. Power fluctuations within a short time 	<ol style="list-style-type: none"> 1. Check the compressor 2. Check the waterway system 3. Check if the power is in the normal range 4. Check the phase sequence connection
Communication failure between controller and main board	EE08	<ol style="list-style-type: none"> 1. Poor signal wire connection or damaged signal wire 2. Controller malfunction 	<ol style="list-style-type: none"> 1. Check and re-connect the signal wire 2. Change a new signal wire 3. Turn off electricity supply and restart machine 4. Change a new controller
Communication failure between Main control board and Driving board	EE09	<ol style="list-style-type: none"> 1. Poor connection of communication wire 2. The wire is damaged 	<ol style="list-style-type: none"> 1. Check the wire connection 2. Change a new wire
VDC voltage too high protection	EE10	<ol style="list-style-type: none"> 1. Mother line voltage is too high 2. Driver board is damaged. 	<ol style="list-style-type: none"> 1. Check if the power is in the normal range 2. Change driver board or main board
IPM module protection	EE11	<ol style="list-style-type: none"> 1. Data mistake 2. Wrong compressor phase connection 3. Compressor liquid and oil accumulation lead to the current becomes larger 	<ol style="list-style-type: none"> 1. Program error, turn off electricity supply and restart after 3 minutes 2. Change driver board 3. Check compressor sequence connection

		4. Compressor or driver board damaged	
VDC voltage too low protection	EE12	1. Mother line voltage is too low 2. Driver board is damaged.	1. Check if the power is in the normal range 2. Change driver board
Input current over high protection.	EE13	1. The compressor current is too large momentary 2. The water flow is abnormal 3. Power fluctuations within a short time 4. Wrong PFC inductor	1. Check the compressor 2. Check the waterway system 3. Check if the power is in the normal range 4. Check if the correct PFC inductor is used
IPM module thermal circuit is abnormal	EE14	1. Output enormity of IPM module thermal circuit 2. Fan motor is abnormal or damaged Fan blade is broken	1. Change a driver board 2. Check if the motor speed is too low or fan motor damaged, change another one 3. Change another fan blade
IPM module temperature too high protection	EE15	1. Output exception of IPM module thermal circuit 2. Motor is abnormal or damaged 3. Fan blade is broken	1. Change a driver board 2. Check if the fan motor speed is too low or fan motor damaged, change another one 3. Change another fan blade
PFC module protection	EE16	1. Output exception of PFC module 2. Motor is abnormal or damaged 3. Fan blade is broken 4. Input voltage leap, input power is abnormal	1. Change a driver board 2. Check if the motor speed is too low or fan motor damaged, change another one 3. Change another fan blade 4. Check the input voltage
DC fan motor failure	EE17	1. DC motor is damaged 2. Main board is damaged 3. The fan blade is stuck	1. Detect DC motor, replace with a new one 2. Change a new main board 3. Find out the barrier and work it out
PFC module thermal circuit is abnormal	EE18	The driver board is damaged	1. Change a new driver board 2. Check if the fan motor speed is too low or fan motor damaged, change another one
PFC module high temperature protection	EE19	1. PFC module thermal circuit output abnormal 2. Motor is abnormal or damaged 3. Fan blade is broken 4. The screw in the driver board is not tight	1. Change a new driver board 2. Check if the motor speed is too low or fan motor damaged, change another one 3. Change another fan blade 4. Check if the screw is loose
Input power failure	EE20	The supply voltage fluctuates too much	Check whether the voltage is stable
Software control exception	EE21	1. Compressor runs out of step 2. Wrong program 3. Impurity inside compressor causes	1. Check the main board or change a new one

		the unstable rotate speed	2. Enter correct program
Current detection circuit failure	EE22	1. Voltage signal abnormal 2. Driver board is damaged	1. Check the main board or change a new one 2. Change a new driver board
Compressor start failure	EE23	1. Main board is damaged 2. Compressor wiring error or poor contact or unconnected 3. Liquid accumulation inside 4. Wrong phase connection for compressor	1. Check the main board or change a new one 2. Check the compressor wiring according to the circuit diagram Check the compressor or change a new one
Ambient Temperature device failure on Driver board	EE24	Ambient Temperature device failure	Change driver board or main board
Compressor phase failure	EE25	Compressors U, V, W are connected to one phase or two phases.	Check the actual wiring according to the circuit diagram
Four-way valve reversal failure	EE26	1. Four-way valve reversal failure 2. Lack of refrigerant (no detect when T3 or T5 malfunction)	1. Switch to Cooling mode to check the 4-way valve if it has been reversed correctly 2. Change a new 4-way valve 3. Fill with gas
EEPROM data read malfunction	EE27	1. Wrong EEPROM data in the program or failed input of EEPROM data 2. Main board failure	1. Re-enter correct EEPROM data 2. Change a new main board
The inter-chip communication failure on the main control board	EE28	Main board failure	1. Turn off electricity supply and restart it 2. Change a new main board

Remarks:

1. In heating mode, if the water out temperature is higher than the set temperature over 7°C LED controller displays EE04 for water over-heating protection.
2. In cooling mode, if the water out temperature is lower than the set temperature over 7°C LED controller displays PP11 for water over-cooling protection.

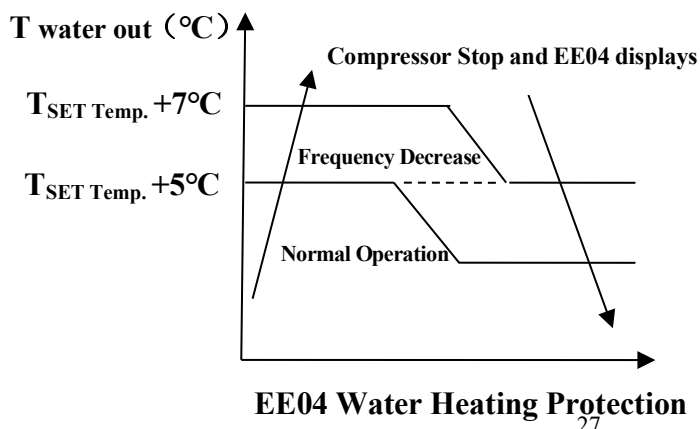

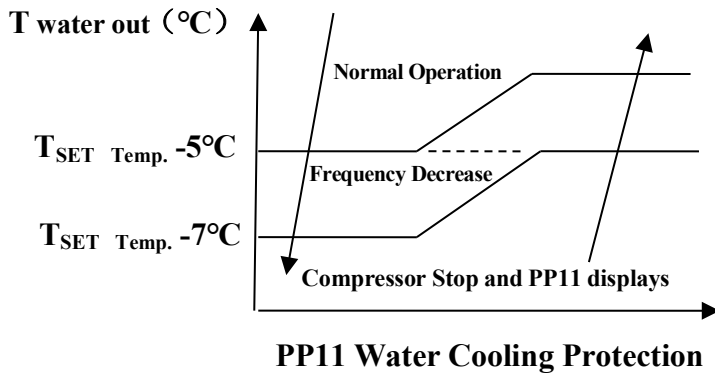

For example below:

Mode	Water out temperature	Setting temperature	Condition	Malfunction
Heating mode	36°C	29°C	$T_{out} - T_{set} \geq 7^{\circ}\text{C}$	EE04 Over heating protection for water temperature (T2)
Cooling mode	23°C	30°C	$T_{set} - T_{out} \geq 7^{\circ}\text{C}$	PP11 Too low protection for water temperature (T2)

6.2 Other Malfunctions and Solutions (No display on LED wire controller)

Malfunctions	Observing	Reasons	Solution
Heat pump is not running	LED wire controller no display.	No power supply	Check cable and circuit breaker if it is connected
	LED wire controller displays the actual time.	Heat pump under standby status	Startup heat pump to run.
	LED wire controller displays the actual water temperature.	1. Water temperature is reaching to setting value, HP under constant temperature status. 2. Heat pump just starts to run. 3. Under defrosting.	1. Verify water temperature setting. 2. Startup heat pump after a few minutes. 3. LED wire controller should display "Defrosting".

Water temperature is cooling when HP runs under heating mode	LED wire controller displays actual water temperature and no error code displays.	<ol style="list-style-type: none"> 1. Choose the wrong mode. 2. Figures show defects. 3. Controller defect. 	<ol style="list-style-type: none"> 1. Adjust the mode to proper running 2. Replace the defect LED wire controller, and then check the status after changing the running mode, verifying the water inlet and outlet temperature. 3. Replace or repair the heat pump unit
Short running	LED displays actual water temperature, no error code displays.	<ol style="list-style-type: none"> 1. Fan NO running. 2. Air ventilation is not enough. 3. Refrigerant is not enough. 	<ol style="list-style-type: none"> 1. Check the cable connections between the motor and fan, if necessary, it should be replaced. 2. Check the location of heat pump unit, and eliminate all obstacles to make good air ventilation. 3 Replace or repair the heat pump unit.
Water stains	Water stains on heat pump unit.	<ol style="list-style-type: none"> 1. Concreting. 2. Water leakage. 	<ol style="list-style-type: none"> 1. No action. 2. Check the titanium heat exchanger carefully if it is any defect.
Too much ice on evaporator	Too much ice on evaporator.		<ol style="list-style-type: none"> 1. Check the location of heat pump unit, and eliminate all obstacles to make good air ventilation. 2. Replace or repair the heat pump unit.

7. Electrical Wiring

UX11Csi32/UX14Csi32/UX17Csi32/UX21Csi32

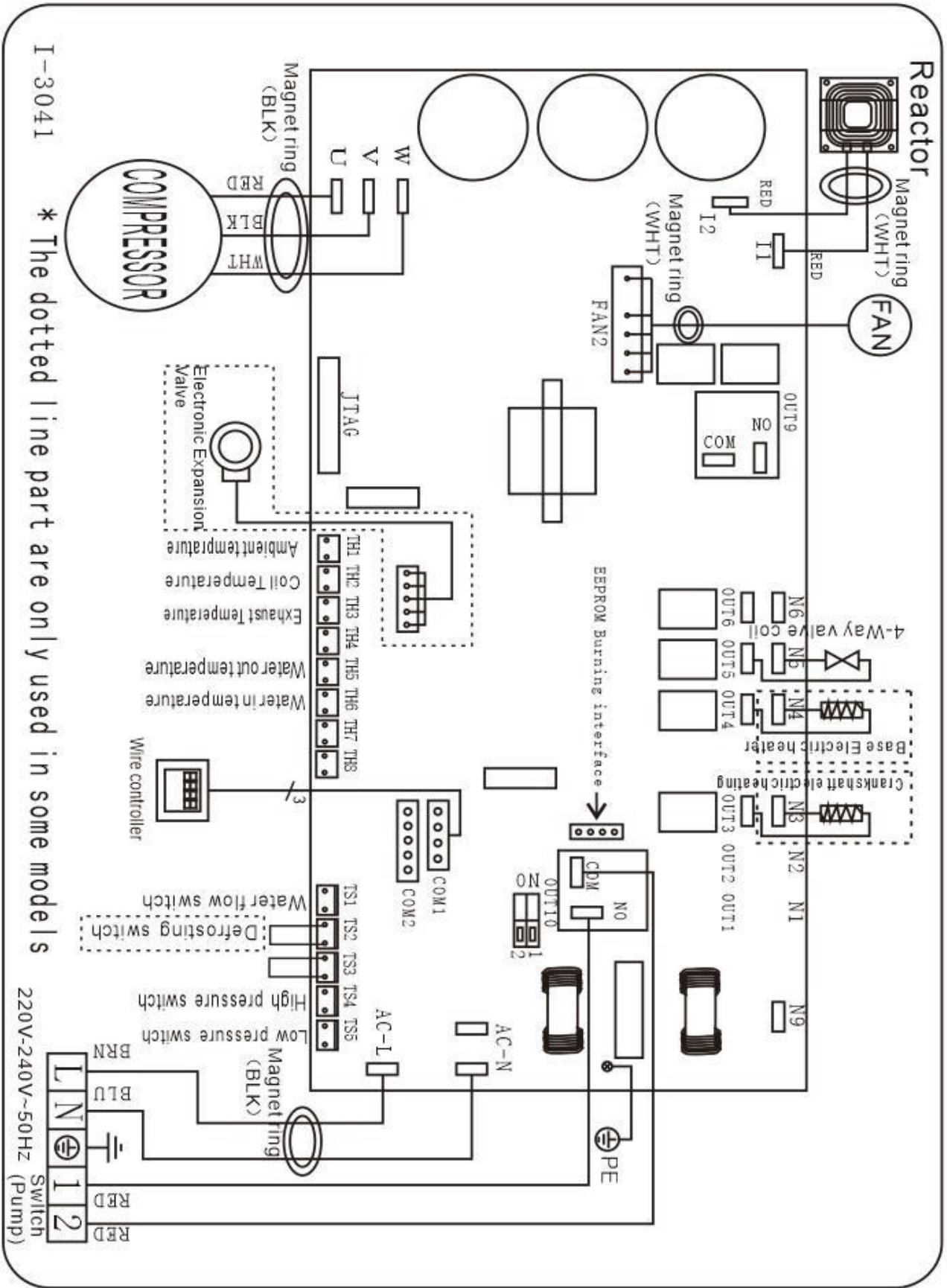

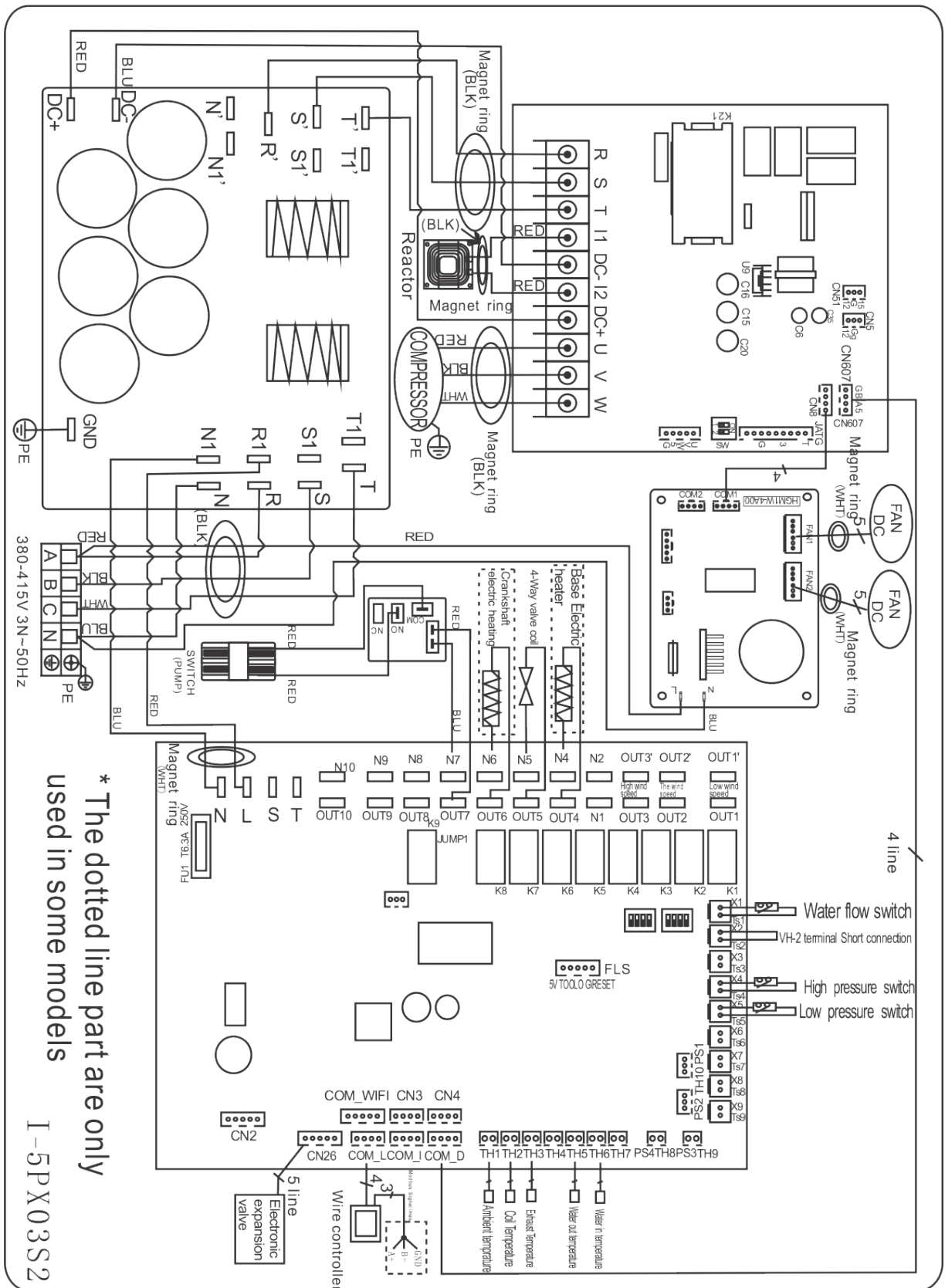

NOTE:

(1) Above electrical wiring diagram only for your reference, please subject machine posted the wiring diagram.

(2) The swimming pool heat pump must be connected ground wire well, although the unit heat exchanger is electrically isolated from the rest of the unit. Grounding the unit is still required to protect you against short circuits inside the unit. Bonding is also required.

Disconnect: A disconnect means (circuit breaker, fused or un-fused switch) should be located within sight of and readily accessible from the unit. This is common practice on commercial and residential heat pumps. It prevents remotely-energizing unattended equipment and permits turning off power at the unit while the unit is being serviced.

8. Maintenance

(1) You should check the water supply system regularly to avoid the air entering the system and occurrence of low water flow, because it would reduce the performance and reliability of HP unit.

(2) Clean your pools and filtration system regularly to avoid the damage of the unit as a result of the dirty or clogged filter.

(3) You should discharge the water from bottom of water pump if HP unit will stop running for a long time (specially during the winter season).

(4) In another way, you should check the unit is water fully before the unit start to run again.

(5) After the unit is conditioned for the winter season, it is recommended to cover the heat pump with special winter heat pump.

(6) When the unit is running, there is all the time a little water discharge under the unit.

9. Exploded view

UX11Csi32/UX14Csi32

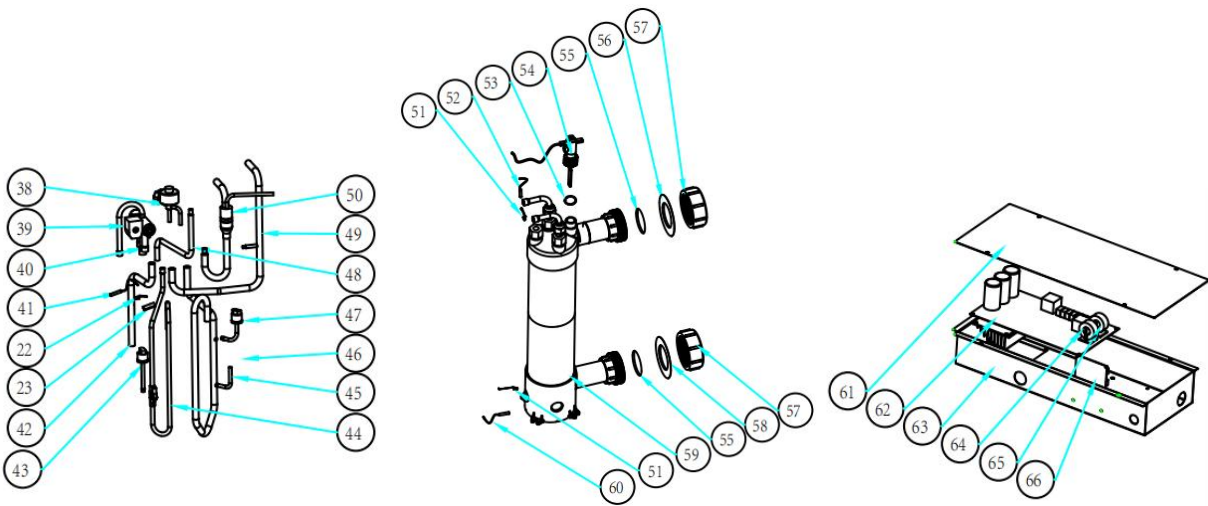
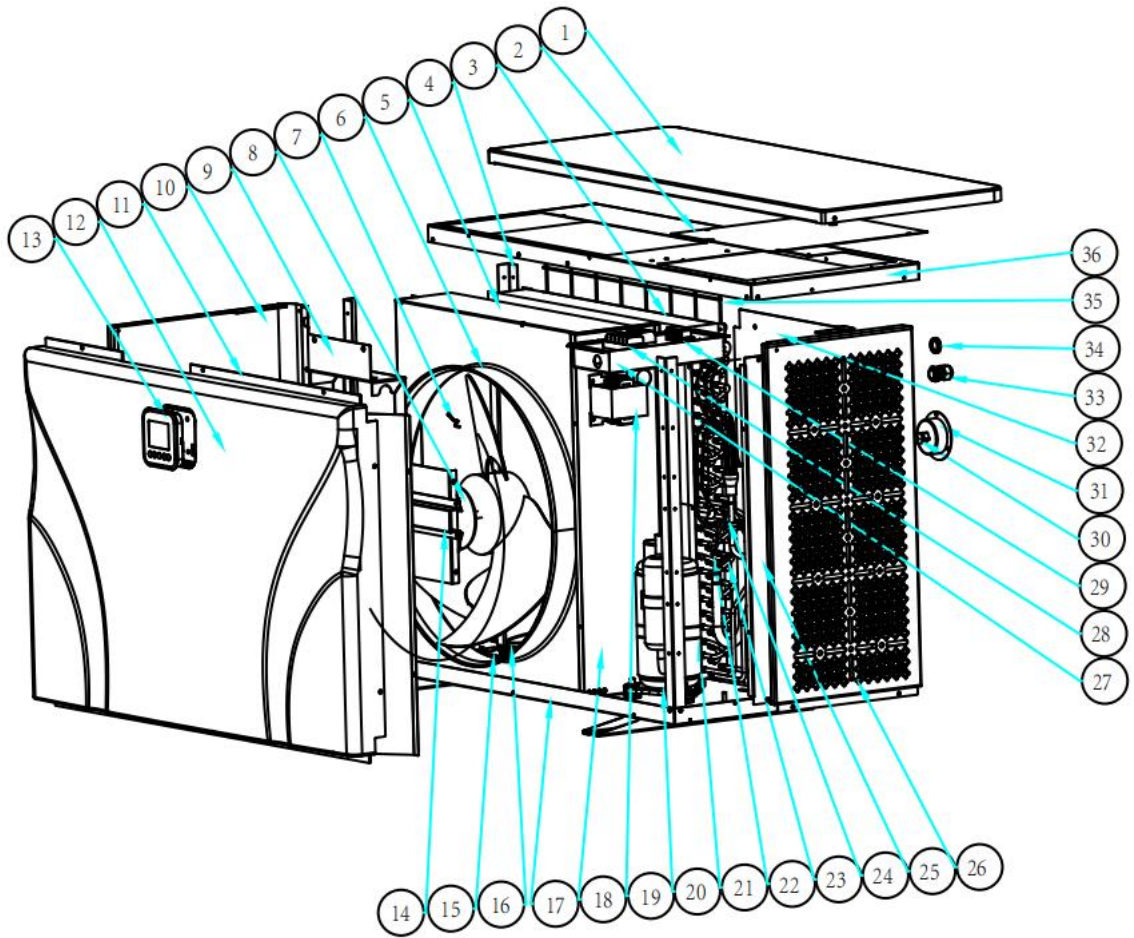

UX11Csi32/UX14Csi32

NO.	Part name	NO.	Part name
1	Top cover	34	Cable passing hole
2	Service panel	35	Back grill
3	Evaporator	36	Top frame
4	Pillar	37	EEV
5	Fan panel	38	4 way valve coil
6	Ambient temp. sensor T5-TH1	39	4 way valve
7	Fan blade	40	Evaporator temperature sensor T3-TH2
8	Fan motor	41	4-way valve to evaporator piping
9	Fan motor bracket	42	High pressure switch
10	Left panel	43	Discharge pipe
11	Service panel	44	Gas return piping
12	Front panel	45	Seal tube
13	Controller	46	Low pressure switch
14	Pillar	47	EEV to distribution piping
15	Evaporator support panel	48	4-way valve to exchanger
16	Evaporator heating resistor	49	Exchanger to EEV
17	Base tray	50	Exchanger temperature sensor clip
18	Isolation panel	51	Water outlet temp. sensor T2-TH5
19	Reactor	52	Rubber ring on water flow switch
20	Compressor	53	Water flow switch
21	Compressor heating resistor	54	PVC cover
22	Sensor clip	55	Red rubber ring
23	Sensor holder	56	Water connection sets
24	Discharge temp. sensor T6-TH3	57	Red rubber ring
25	Service panel	58	Titanium heat exchanger
26	Right panel	59	Water inlet temp. sensor T1-TH6
27	Terminal board	60	Electric box cover
28	Power terminal	61	PCB
29	Clip	62	Electric box
30	Screw	63	Magnet ring
31	Pressure gauge	64	Magnet ring
32	Back panel	65	Wifi module
33	Cable connector		

UX17Csi32/UX21Csi32

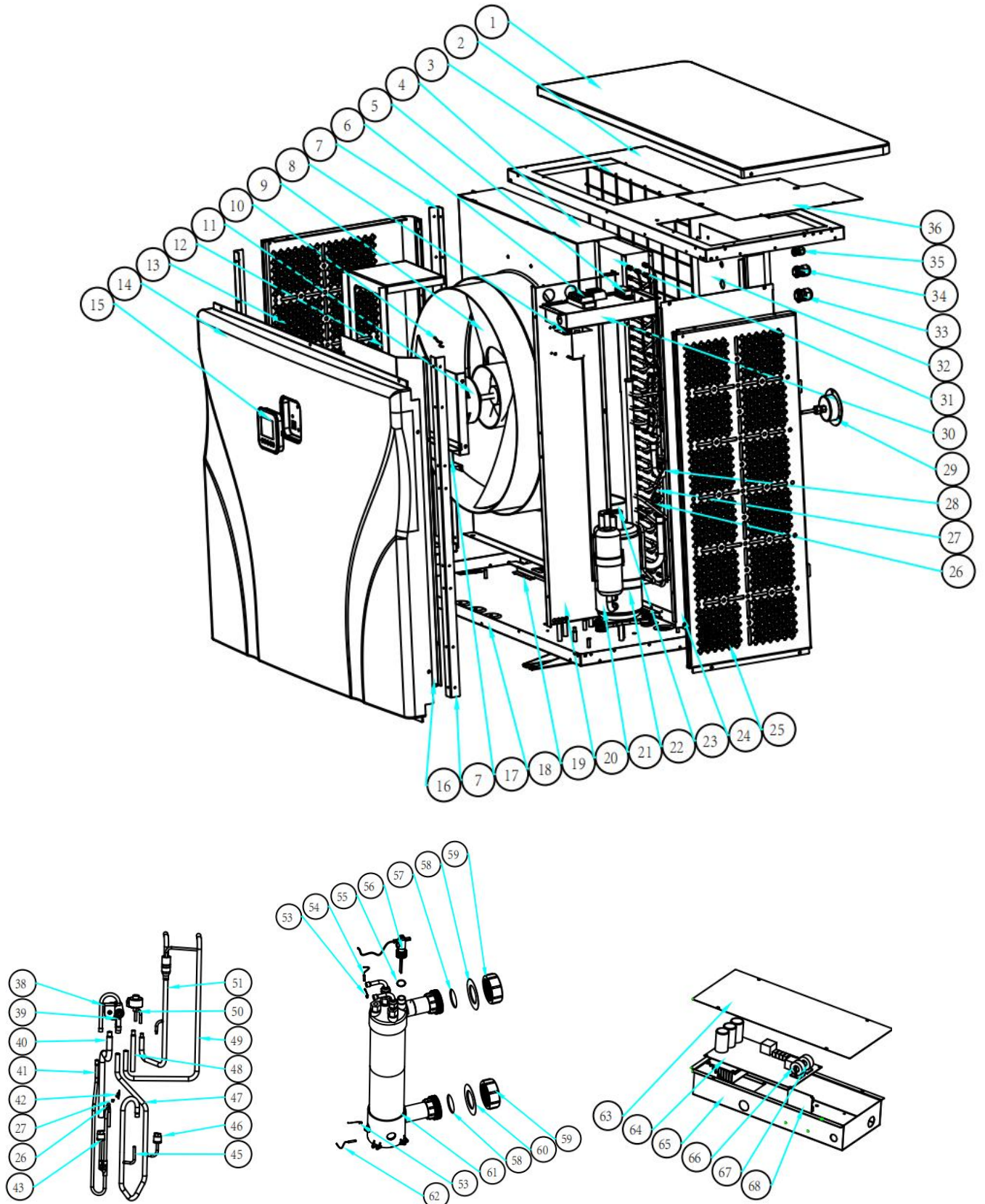

UX17Csi32

NO.	Part name	NO.	Part name
1	Top cover	35	Cable connector
2	Top frame	36	Service panel
3	Back grill	37	#N/A
4	Fan panel	38	4 way valve coil
5	Clip	39	4 way valve
6	Power terminal	40	4-way valve to evaporator piping
7	Pillar	41	Discharge pipe
8	Reactor	42	Evaporator temperature sensor T3-TH2
9	Fan blade	43	High pressure switch
10	Fan motor	44	#N/A
11	Ambient temp. sensor T5-TH1	45	Seal tube
12	Fan motor bracket	46	Low pressure switch
13	Left panel	47	Gas return piping
14	Front panel	48	EEV to distribution piping
15	Controller	49	4-way valve to exchanger
16	Service panel	50	EEV
17	Pillar	51	Exchanger to EEV
18	Base tray	52	#N/A
19	Evaporator support panel	53	Exchanger temperature sensor clip
20	Isolation panel	54	Water outlet temp. sensor T2-TH5
21	Compressor	55	Rubber ring on water flow switch
22	Compressor heating resistor	56	Water flow switch
23	Evaporator heating resistor	57	PVC cover
24	Service panel	58	Red rubber ring
25	Right panel	59	Water connection sets
26	Sensor holder	60	Blue rubber ring
27	Clip	61	Titanium heat exchanger
28	Discharge temp. sensor T6-TH3	62	Water inlet temp. sensor T1-TH6
29	Pressure gauge	63	Electric box cover
30	Terminal board	64	PCB
31	Evaporator	65	Electric box
32	Back panel	66	Magnet ring
33	Cable connector	67	Magnet ring
34	Cable connector	68	Wifi module

UX21Csi32

NO.	Part name	NO.	Part name
1	Top cover	35	Cable connector
2	Top frame	36	Service panel
3	Back grill	37	4 way valve
4	Fan panel	38	4 way valve coil
5	Clip	39	EEV
6	Power terminal	40	EEV to distribution piping
7	Pillar	41	4-way valve to evaporator piping
8	Reactor	42	High pressure switch
9	Fan blade	43	Evaporator temperature sensor T3-TH2
10	Fan motor	44	Discharge pipe
11	Ambient temp. sensor T5-TH1	45	Liquid storage tank
12	Fan motor bracket	46	Gas return piping
13	Left panel	47	Filter to storage tank
14	Front panel	48	Low pressure switch
15	Controller	49	Liquid storage tank to EEV
16	Service panel	50	4-way valve to exchanger
17	Pillar	51	Dehydrator filter
18	Base tray	52	Exchanger to filter
19	Evaporator support panel	53	Exchanger temperature sensor clip
20	Isolation panel	54	Water outlet temp. sensor T2-TH5
21	Compressor	55	Rubber ring on water flow switch
22	Compressor heating resistor	56	Water flow switch
23	Evaporator heating resistor	57	PVC cover
24	Service panel	58	Red rubber ring
25	Right panel	59	Water connection sets
26	Sensor holder	60	Blue rubber ring
27	Clip	61	Titanium heat exchanger
28	Discharge temp. sensor T6-TH3	62	Water inlet temp. sensor T1-TH6
29	Pressure gauge	63	Electric box cover
30	Terminal board	64	PCB
31	Evaporator	65	Electric box
32	Back panel	66	Magnet ring
33	Cable connector	67	Magnet ring
34	Cable connector	68	Wifi module

UX30Csi32T/UX35Csi32T

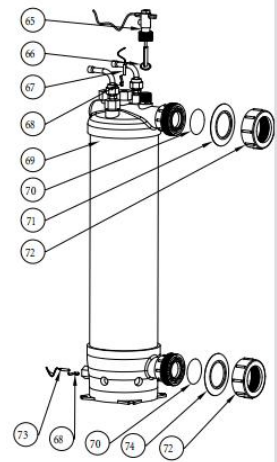
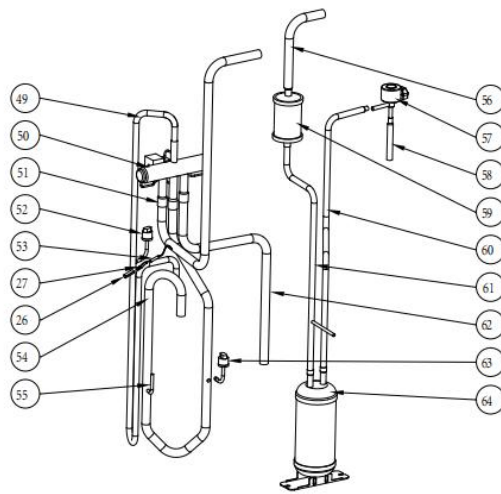
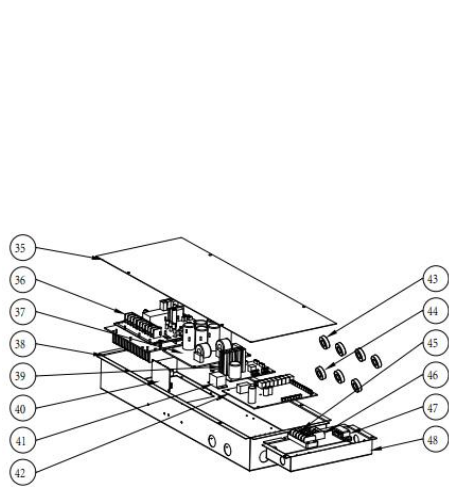
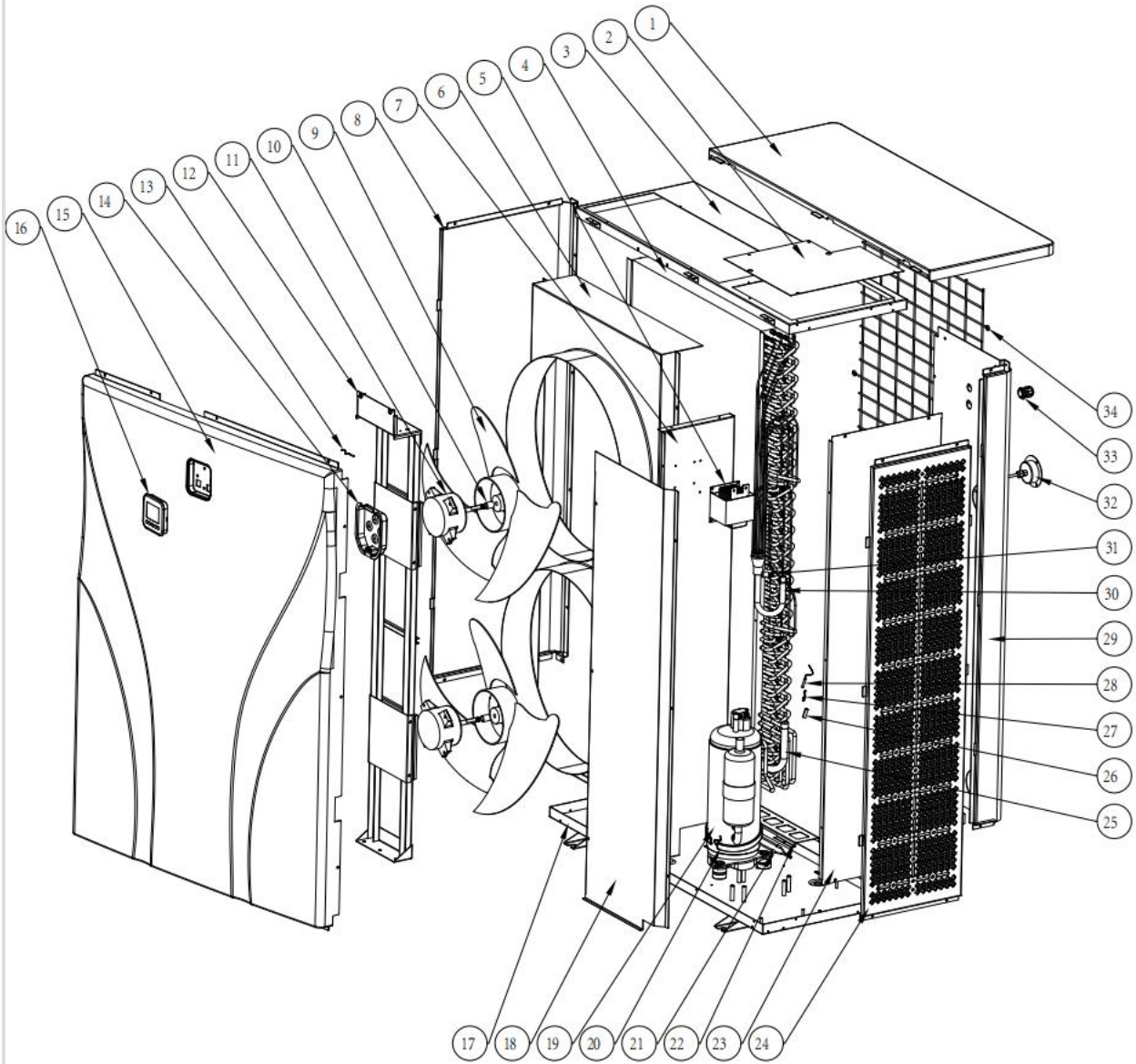

UX30Csi32T/UX35Csi32T

NO.	Part name	NO.	Part name
1	Top cover	38	Electric box
2	Service panel	39	#N/A
3	Top frame	40	Wifi module
4	Evaporator	41	Relay
5	Reactor	42	PCB
6	Fan panel	43	Magnet ring
7	Isolation panel	44	Magnet ring
8	Left panel	45	Power terminal
9	Fan blade	46	Power terminal
10	Fan motor assembly	47	Clip
11	Fan motor	48	Terminal board
12	Fan motor bracket	49	Discharge pipe
13	Ambient temp. sensor T5-TH1	50	4 way valve
14	Controller installation box	51	4-way valve to exchanger
15	Front panel	52	High pressure switch
16	Controller	53	Discharge temp. sensor T6-TH3
17	Base tray	54	Gas return piping
18	Service panel	55	Seal tube
19	Compressor	56	Exchanger to filter
20	Compressor heating resistor	57	EEV
21	Evaporator heating resistor	58	EEV to distribution piping
22	Evaporator support panel	59	Dehydrator filter
23	Service panel	60	Liquid storage tank to EEV
24	Right panel	61	Filter to storage tank
25	Evaporator pipe	62	4-way valve to evaporator piping
26	Sensor holder	63	Low pressure switch
27	Sensor clip	64	Liquid storage tank
28	Evaporator temperature sensor T3-TH2	65	Water flow switch
29	Back panel	66	Rubber ring on water flow switch
30	Distribution piping	67	Water outlet temp. sensor T2-TH5
31	Rubber block	68	Exchanger temperature sensor clip
32	Pressure gauge	69	Titanium heat exchanger
33	Cable connector	70	Rubber ring on water connection
34	Back grill	71	Red rubber ring
35	Electric box cover	72	Water connection sets
36	Driver board 3 phase	73	Water inlet temp. sensor T1-TH6
37	Filter board	74	Blue rubber ring

A0188UXI02